

# Add Chair

Light gray

Mustard

Dark orange

Terracota PU

Black PU

Teulat

[www.teulat.es](http://www.teulat.es)

Model 1

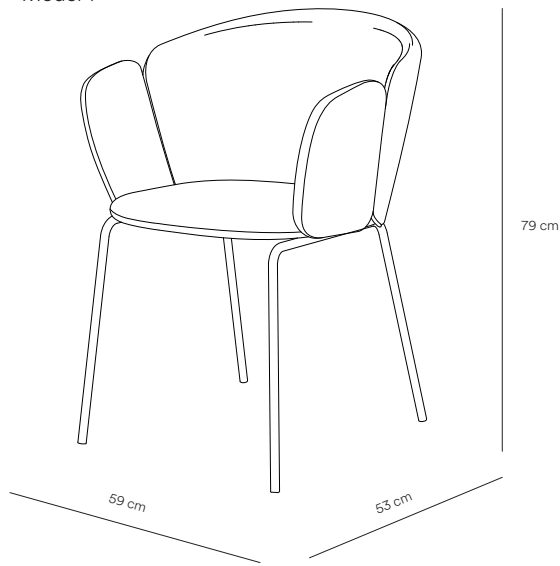

Model 3

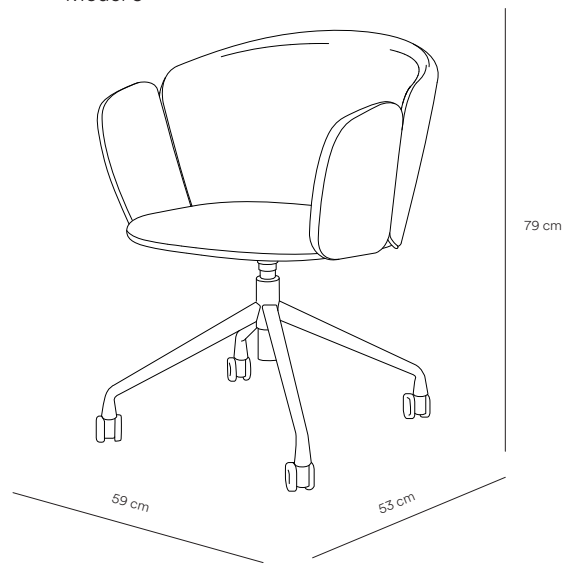

Model 2

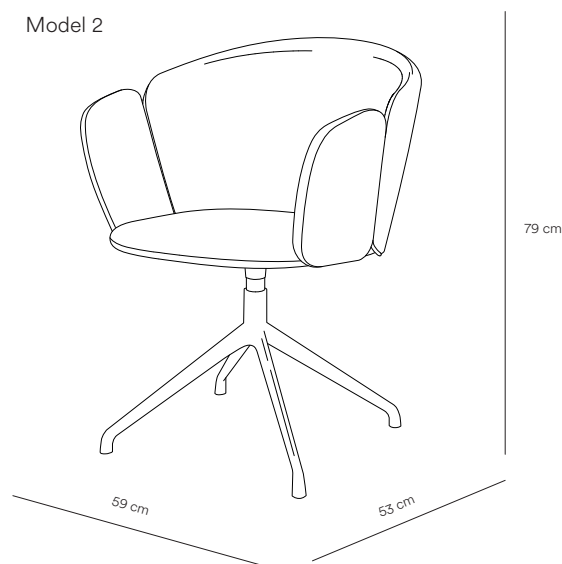

**ATTENTION**

- Before starting, carefully read the assembly instruction and prepare your working area.
- Save this document for future reference.

	Model 1 & 2	Model 3
Packed dimensions	65x61x91 cm (2P/B)	65x61x91 cm (1P/B)
Gross weight	21 kg	11 kg
Net weight	19 kg	10 kg

Needed for assembly

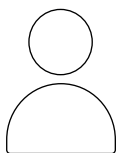

1 person

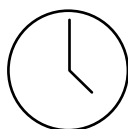

15 min

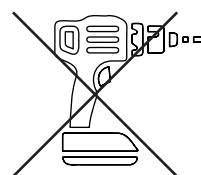

Do not use power  
screwdriver to assemble

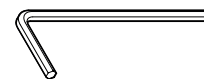

M6

## CAUTION

With a little care you can prolong the life of your furniture and keep the materials in good condition. Follow the instructions for the materials of your specific product to make sure that it stays in the best shape for as long as possible. The information below is only intended as a general guideline. For more information on how to remove specific stains, please enquire where you bought the furniture.

- Avoid placing the table in direct sunlight or near a heat source to reduce changes.
- When you move the furniture, make sure to lift it rather than pulling or pushing it to avoid damaging the floor, legs and mountings.
- Tighten up the screws after one to two months use.
- Avoid improper use such as putting your feet on the table and standing on it.
- Use coasters under damp, hot or coloured objects to avoid permanent stains.
- Avoid covering the surface partially, for example with tablecloths or placemats, as colour variances may appear.
- Furniture containing wood-based panels (Particle board, fibreboard, plywood...) could emit pollutants on the air. Therefore, it is advisable to ventilate the furniture at least during four weeks after its assembly in order to reduce the exposure to the pollutants released by the furniture.



## TELA

-Aspira los muebles con regularidad utilizando la boquilla para tapicerías para eliminar el polvo, prevenir la formación de pelusas y evitar la formación de bolitas.

-De vez en cuando, alise la tela con las manos. Utilice un vaporizador para eliminar las arrugas del tejido.

-En caso de derrame, absorba inmediatamente el líquido con un paño o servilleta, frotando suavemente hacia el centro de la mancha. Es importante no utilizar nunca detergentes concentrados, lejía, amoníaco, blanqueadores ópticos o jabón destinado a superficies duras.

-Desaconsejamos intentar eliminar manchas y marcas individuales mediante la limpieza puntual, ya que esto puede dañar el tejido y provocar la pérdida de color.

## TISSU

-Passez régulièrement l'aspirateur sur les meubles à l'aide de l'embout pour tissus d'ameublement afin d'éliminer la poussière, d'empêcher les peluches et d'éviter les bouloches.

-Redressez de temps en temps le tissu avec vos mains. Utilisez un défroisseur pour éliminer les plis du tissu.

-En cas de déversement, absorbez immédiatement le liquide à l'aide d'un chiffon ou d'une serviette, en tamponnant doucement vers le centre de la tache. Il est important de ne jamais utiliser de détergents concentrés, d'eau de Javel, d'ammoniaque, d'azurants optiques ou de savon destiné aux surfaces dures.

-Il est déconseillé d'essayer d'éliminer des taches et des marques individuelles par un nettoyage ponctuel, car cela peut endommager le tissu et entraîner une perte de couleur.

## FABRIC

-Vacuum the furniture regularly using the upholstery nozzle to remove dust, prevent fluff and avoid pilling.

-Occasionally straighten the fabric with your hands. Utilise a steamer to eliminate wrinkles in the fabric.

-In the event of any spills, immediately absorb the liquid with a cloth or napkin, dabbing gently towards the centre of the stain. It is important to never use concentrated detergents, bleach, ammonia, optical brighteners or soap intended for hard surfaces.

-We advise against attempting to remove individual stains and marks through spot cleaning as this can harm the fabric and lead to loss of colour.

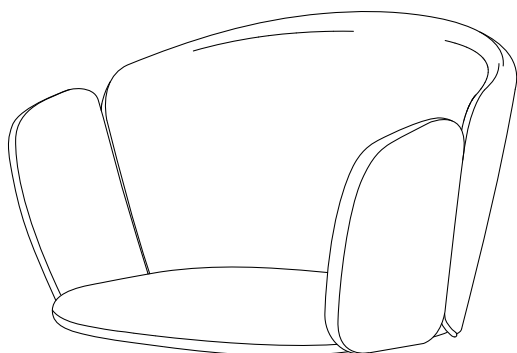

1

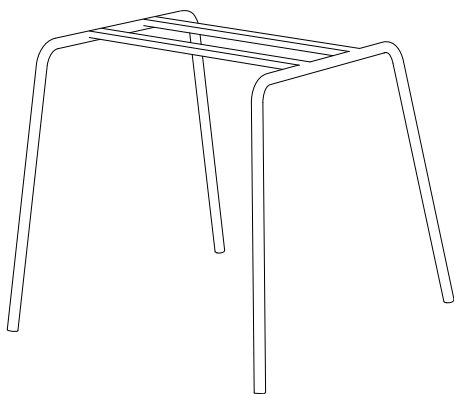

2\*

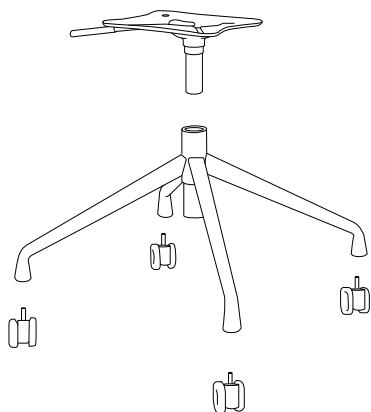

2\*

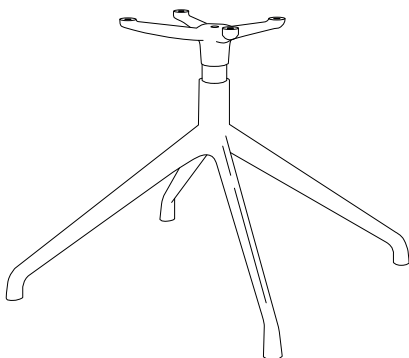

2\*

\*Un único juego de patas incluido según el modelo elegido. / One set of legs included depending on the model chosen.

MONTAJE A / ASSEMBLY A / MONTAGE A

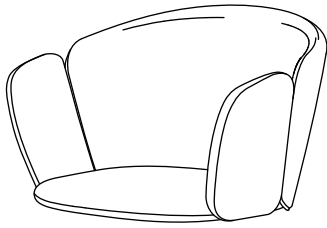

1 x 01 pc

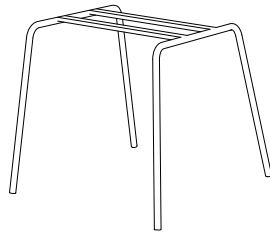

2 x 01 pc

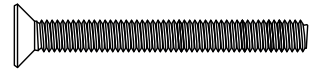

A x 04 pc

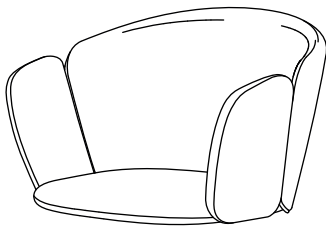

1 x 01 pc

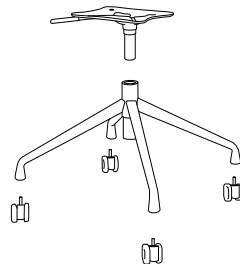

2 x 01 pc



A x 04 pc

MONTAJE B / ASSEMBLY B / MONTAGE B

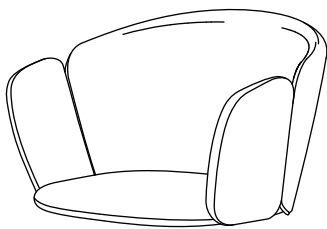

1 x 01 pc

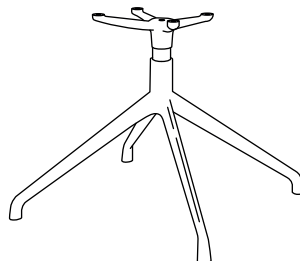

2 x 01 pc



B x 04 pc

\*Un único juego de patas incluido según el modelo elegido. / One set of legs included depending on the model chosen.

Step 01 / Etape 01

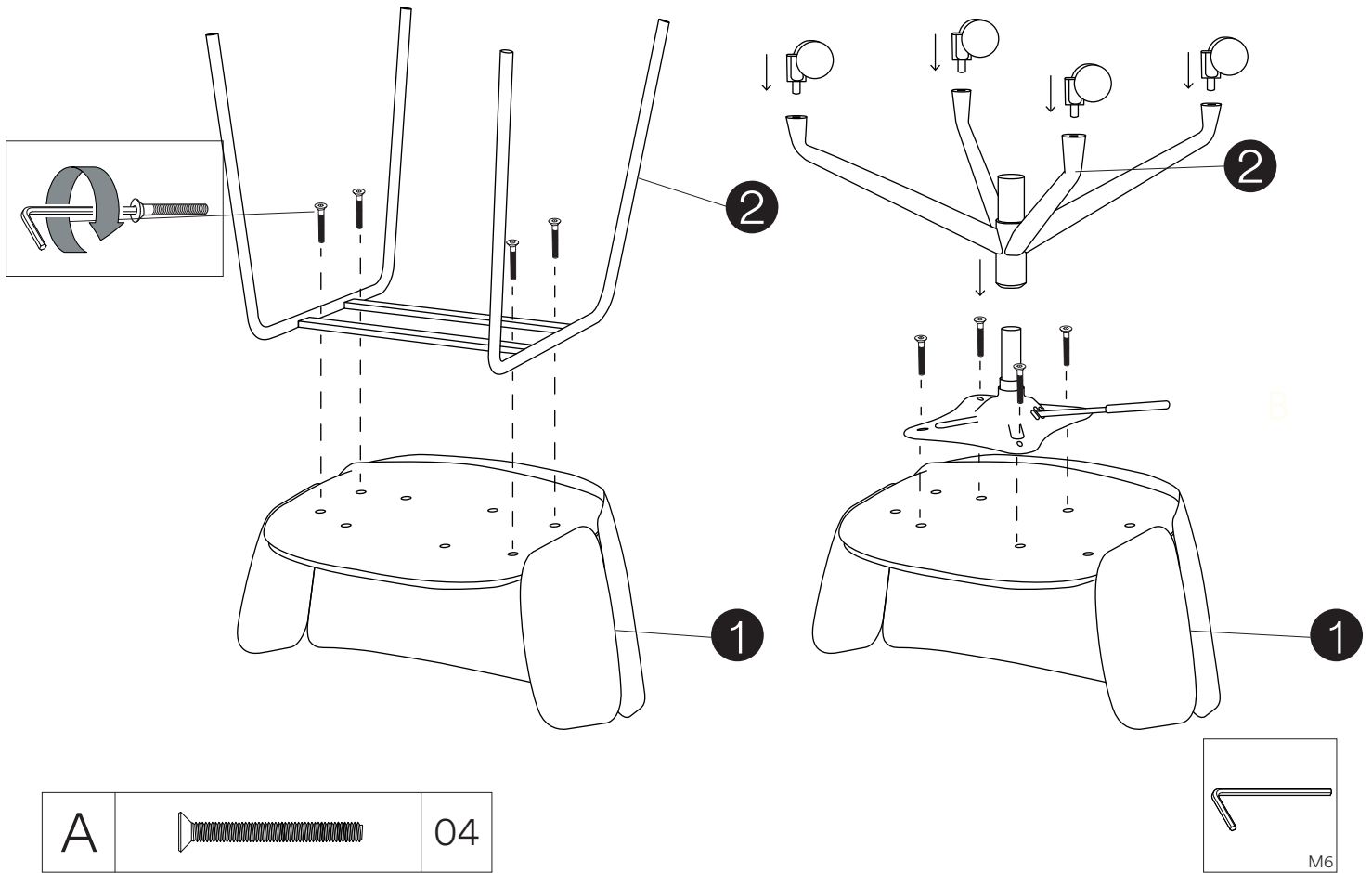

Step 02 / Etape 02

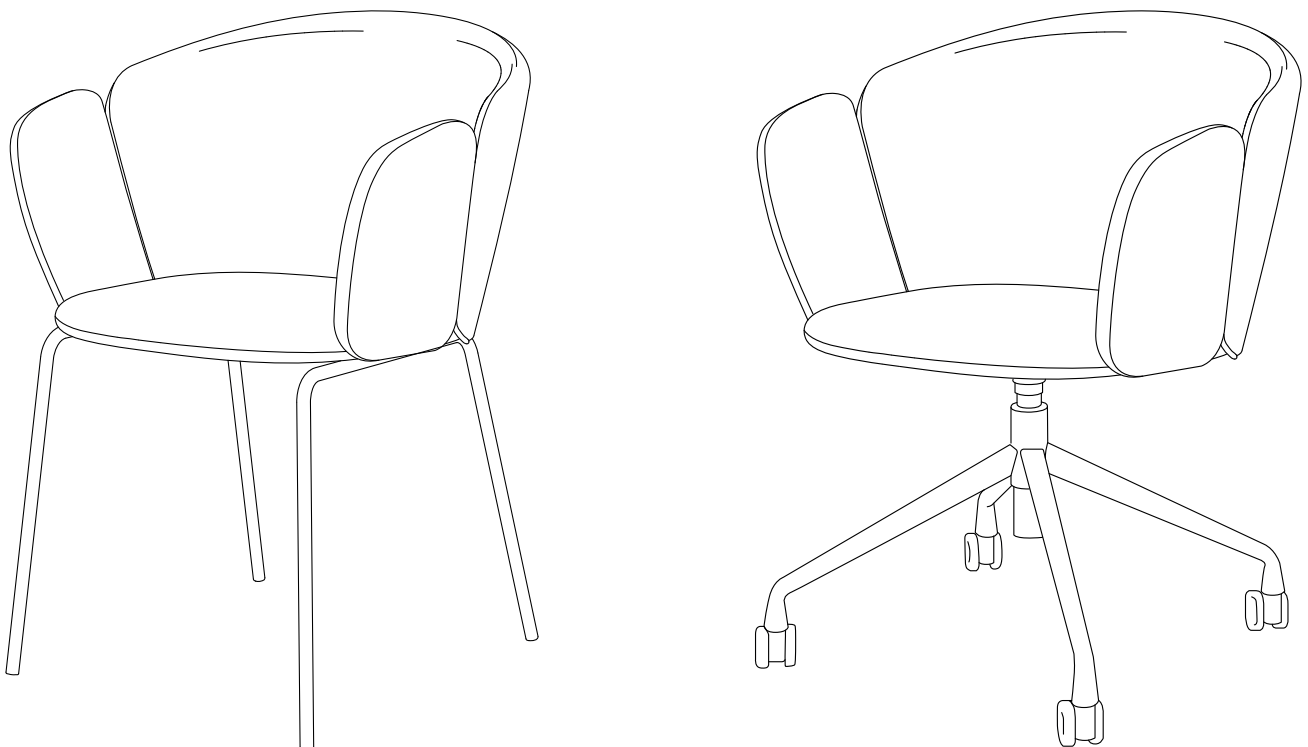

Step 01 / Etape 01

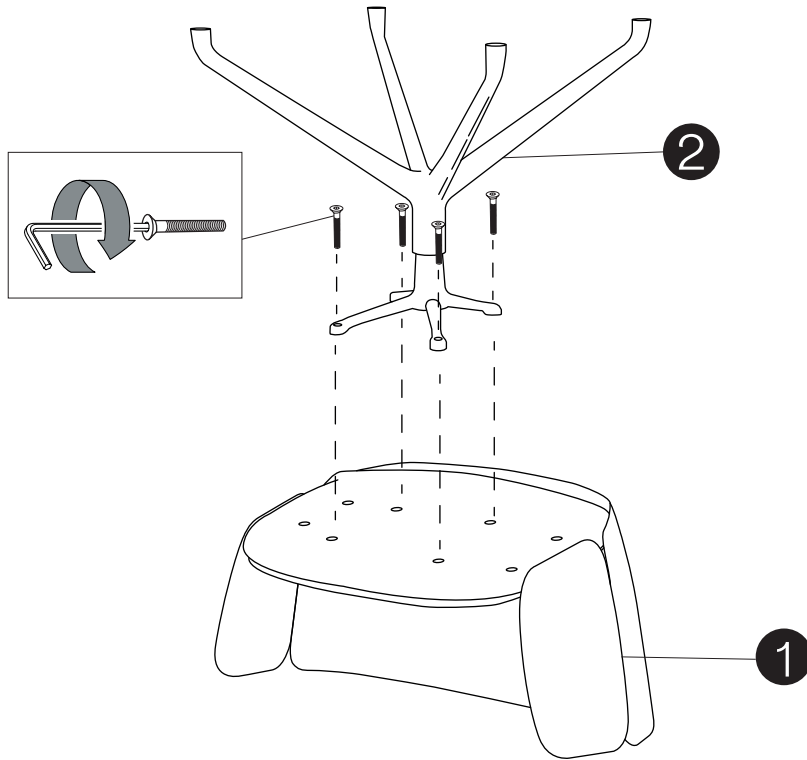

B		04
---	---	----

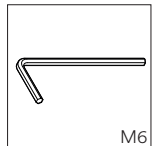

Step 02 / Etape 02

