

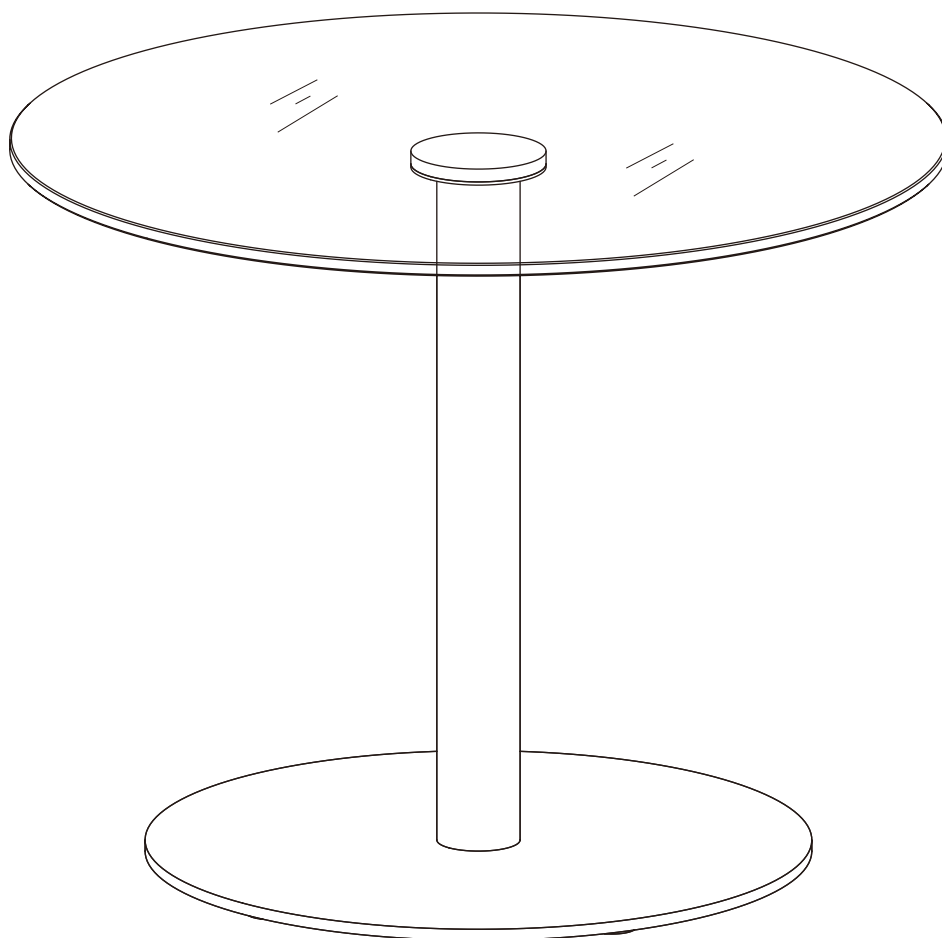

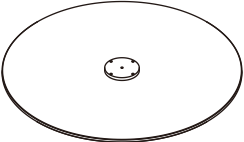

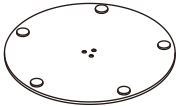

ASSEMBLY INSTRUCTION

<<Before assembling, read all the instruction>>

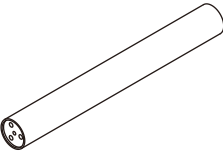
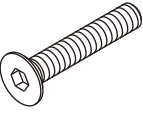
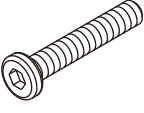

 Ax1	 Bx1	 Cx1	 Dx1	 M8x30 Ex3
 M8x30 Fx3	 M6x12 Gx4	 Hx4	 M4 Jx1	 M5 Kx1

1

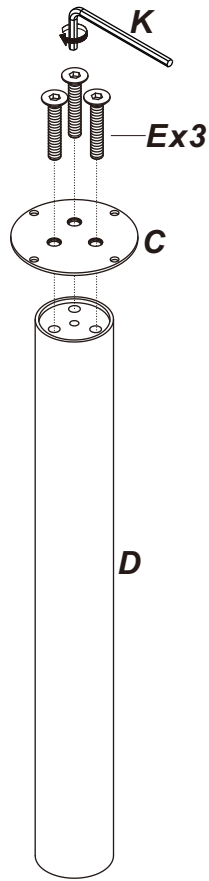

2

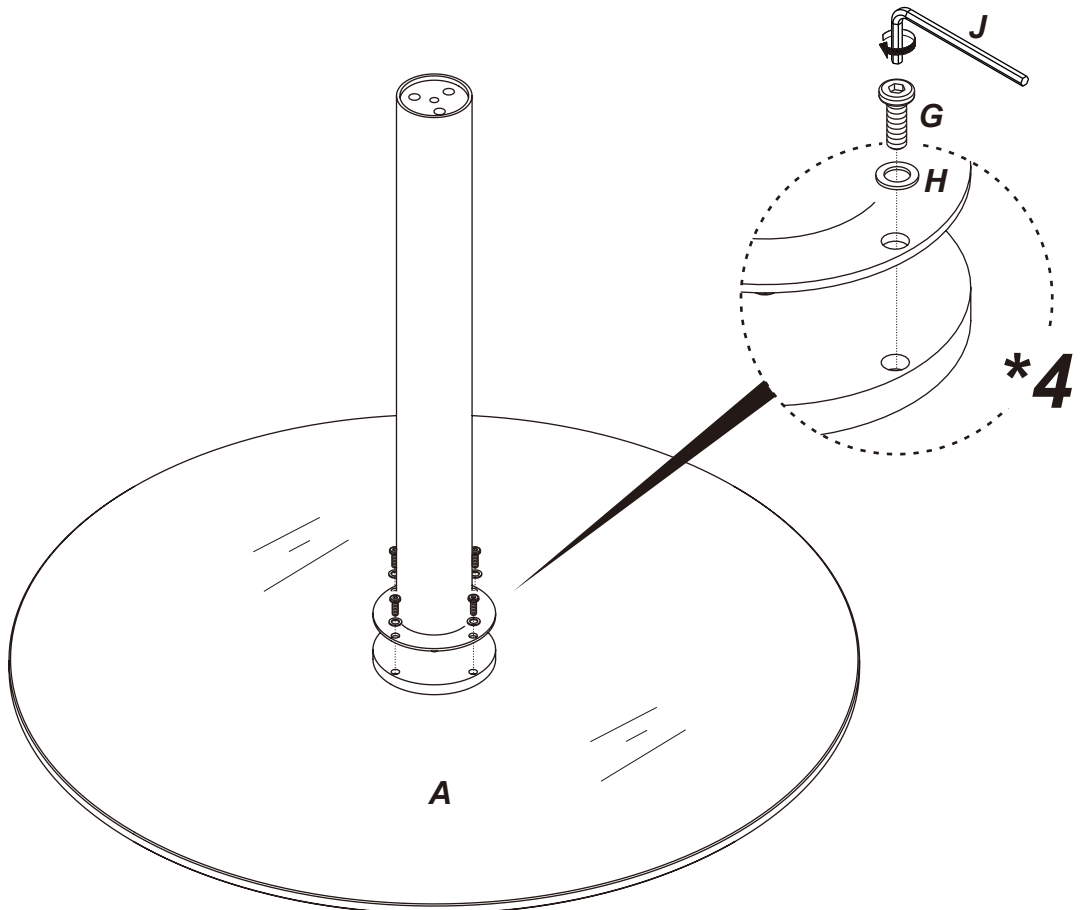

3

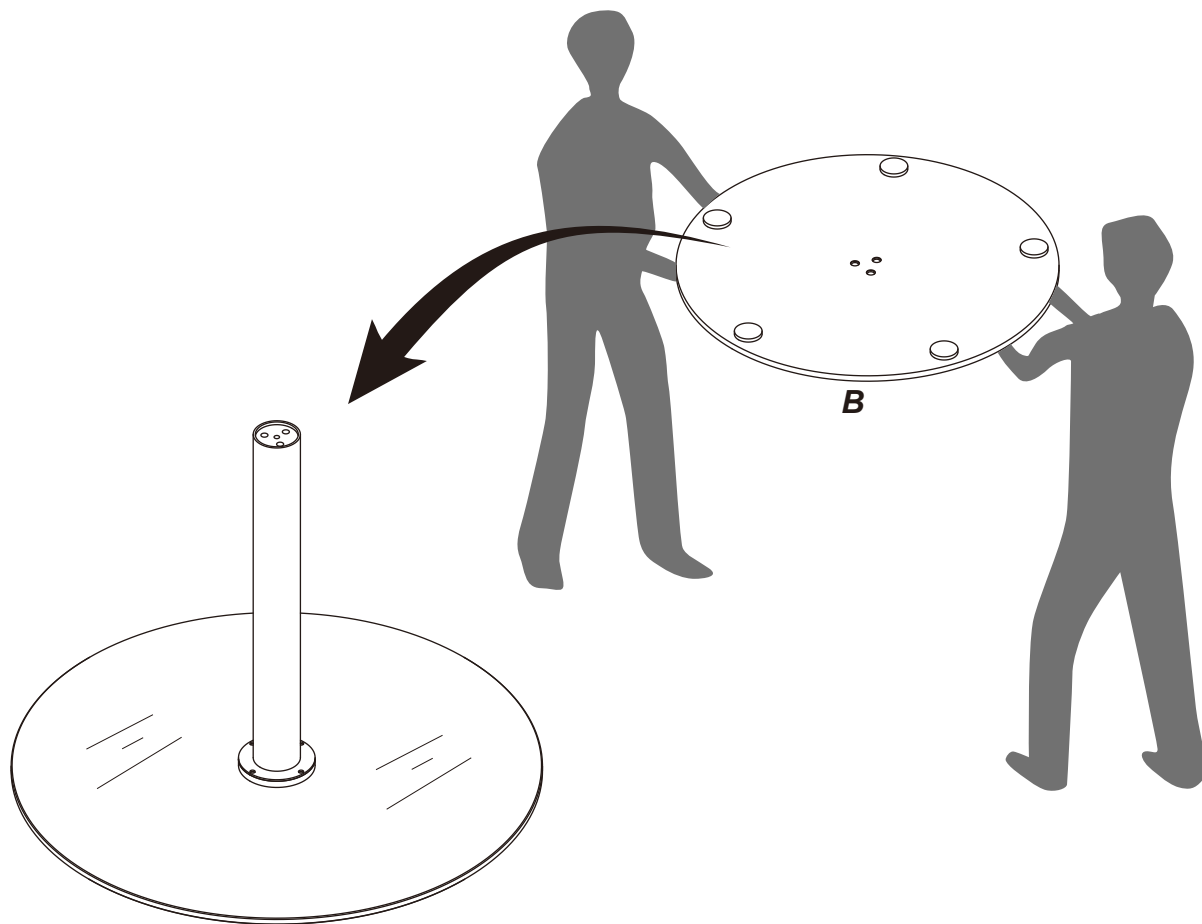

4

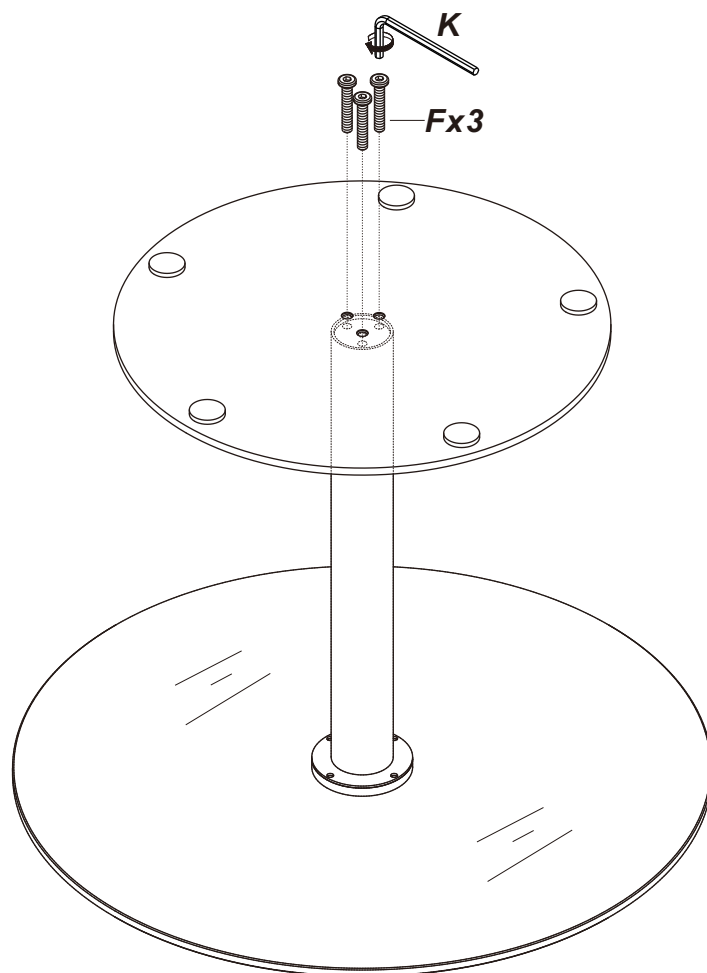

5

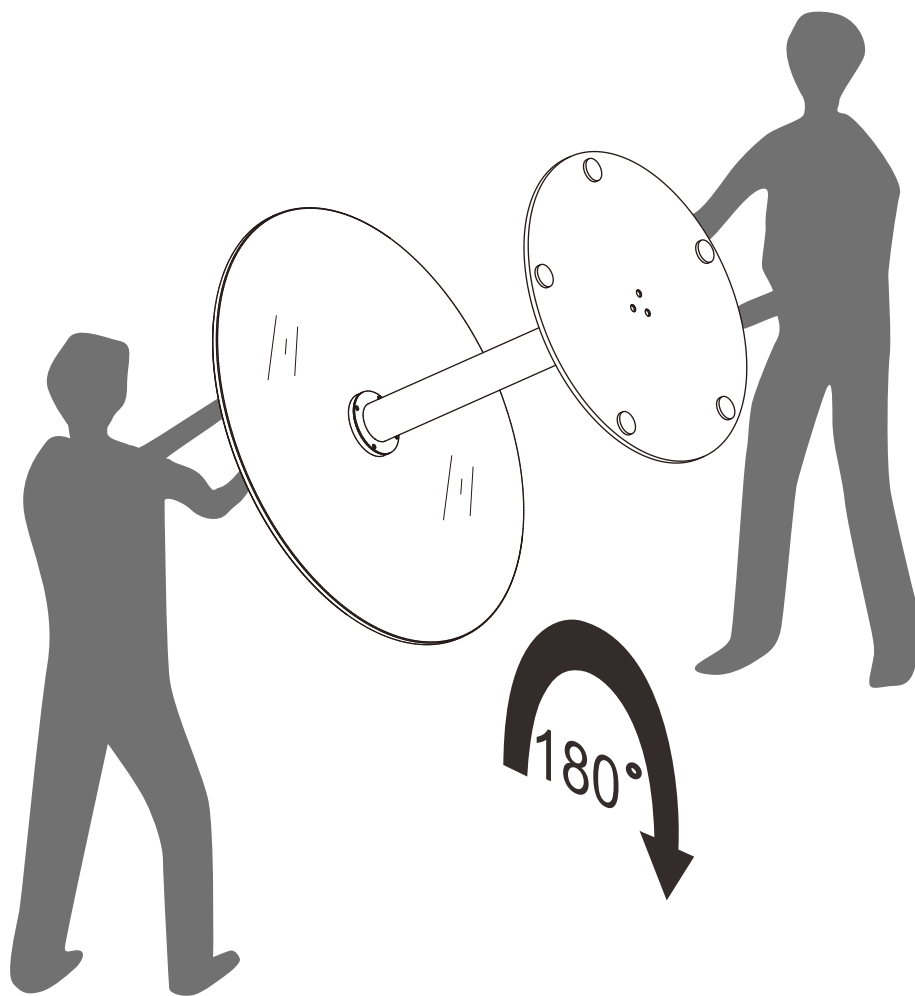

6

