

THIS INSTRUCTION BOOKLET CONTAINS  
**IMPORTANT** SAFETY INFORMATION. PLEASE  
READ AND KEEP FOR FUTURE REFERENCE.



DO NOT RETURN PRODUCT TO THE STORE  
Individual stores do not stock parts.

Lot Number: \_\_\_\_\_

Date Of Purchase: \_\_\_\_/\_\_\_\_/\_\_\_\_

If a part is missing or damaged, call our toll-free customer service line.  
We will gladly ship your replacement parts FREE of charge.

Need Parts or Assistance?

**1-800-489-3351**  
or access our website  
[www.ameriwood.com/parts](http://www.ameriwood.com/parts)

For prompt, reliable service please have your assembly manual ready.

Recommended # of people needed for assembly:2  
(However it is always better to have an extra hand.)

Spanish translations are located in the center of this manual.

Thank you for purchasing from AMERIWOOD.

Visit [www.ameriwood.com](http://www.ameriwood.com) to view the limited warranty valid in the U.S. and Canada.

## BEFORE STARTING

- Read each step carefully before starting. It is very important that each step of instruction is performed in the correct order. If these steps are not followed in sequence, assembly difficulties will occur.
- Make sure all parts are included. Most board parts are labeled or stamped on the raw edge.
- Work in spacious area, preferably on a carpet, near the place the unit will be used.
- Have the following tools close at hand.
- Do not use power tools to assemble your furniture. Power tools may strip or damage the parts.

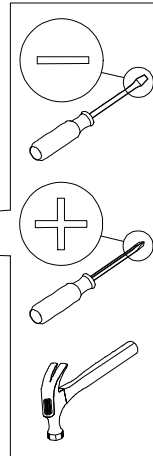

## HELPFUL HINTS

- Visit our website for assembly video clips.
- Call our toll free number if you need assistance.
- Compression dowels are tapped in with a hammer.
- Back panels provide stability and support. Use all the nails provided. Units without the back panel installed may collapse.
- When tapping nails into a board, be sure there are equal margins on all side to square the unit.
- Move your new furniture carefully, with two people lift and carry the unit to it's new location.
- Never push, drag or scoot your furniture (especially on carpet).
- Your ALTRAFURNITURE can be disassembled and reassembled to move.
- Additional parts are available for a nominal fee.

For help with assembly, identifying parts, product information or to order parts, please contact us:

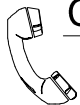

Call us at: 1-800-489-3351

Monday-Friday

9:00 am - 5:00 pm

(Central Time)



FAX:

1-636-745-1005

available 24 hours a day,  
7 days a week

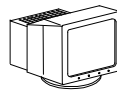

Visit our website:

[www.ameriwood.com/parts](http://www.ameriwood.com/parts)



Write to:

AMERIWOOD INDUSTRIES  
410 East 1st Street South  
Wright City, MO 63390 USA  
Attn: Service Dept.

PARTS

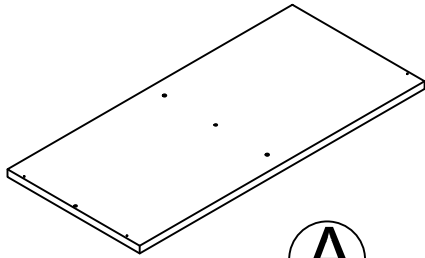

A

TOP  
T1748196010

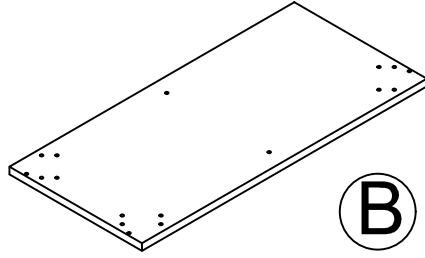

B

BOTTOM  
T1748196020

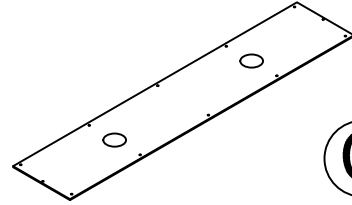

C

BACK PANEL  
T1748196030

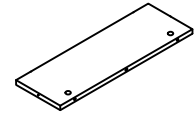

D

LEFT SIDE PANEL  
T1748196040

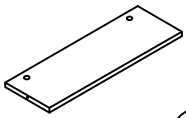

E

RIGHT SIDE PANEL  
T1748196050

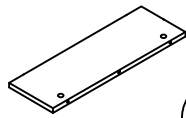

F

PARTITION  
T1748196060



G

LEG  
T1748196070  
QTY:4

# PARTS

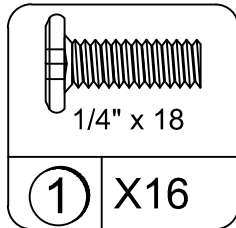

1/4" x 18

① X16

BOLT  
TTL2060  
Spare: 2

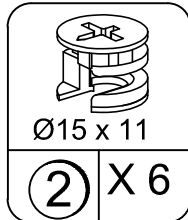

Ø15 x 11

② X 6

CAM LOCK  
TTL6025  
Spare:1

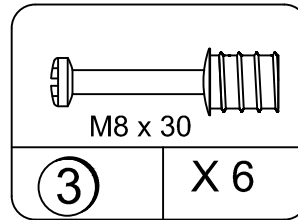

M8 x 30

③ X 6

CAM BOLT  
TTL6026  
Spare:1

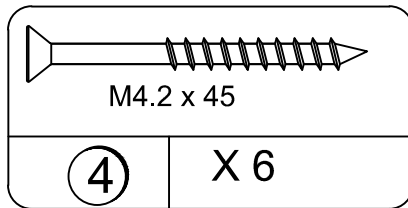

M4.2 x 45

④ X 6

SCREW  
TTL1079  
Spare:1

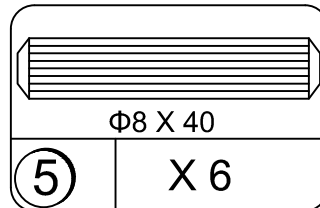

Ø8 X 40

⑤ X 6

WOOD DOWEL  
TTL4005  
Spare:1

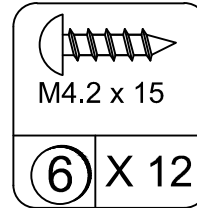

M4.2 x 15

⑥ X 12

SCREW  
TTL1009  
Spare:2

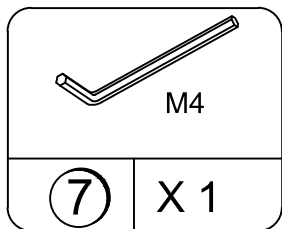

M4

⑦ X 1

HEX KEY  
TTL5015



**WARNING  
ADVERTENCIA**

WARNING LABEL  
TTL1748

This illustration shows how the CAM fastening system works.

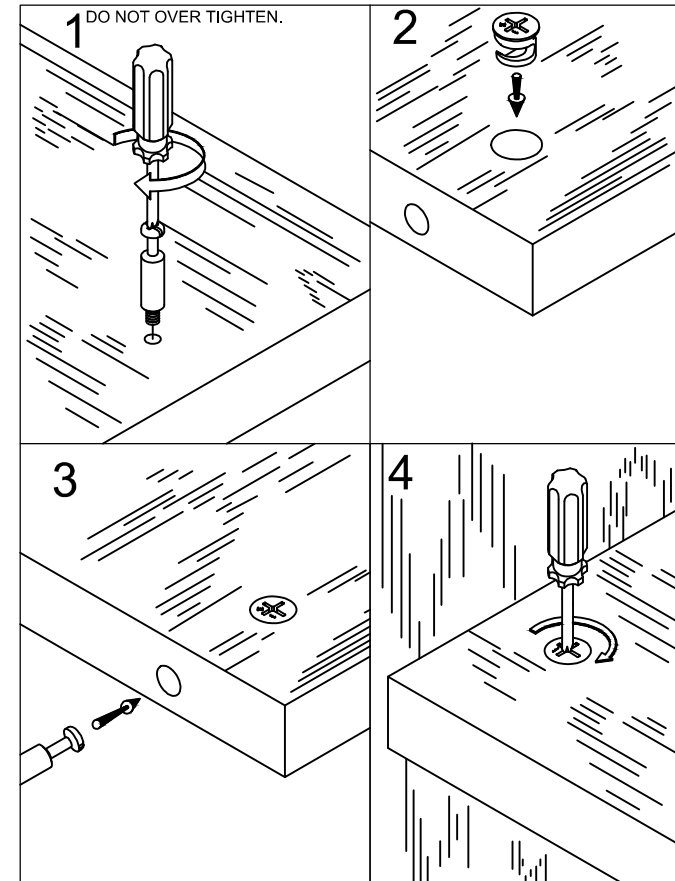

To view a video on how the CAM fastening system works, download a free QR-reader on your smartphone, then scan the code.

# 1

- Screw six cam bolts (3) into the holes of top (A) as below shown.
- Insert three wood dowel (5) into the holes of top (A) as below shown.

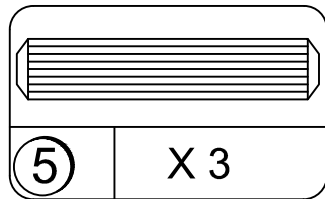
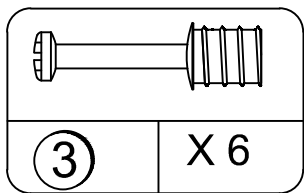
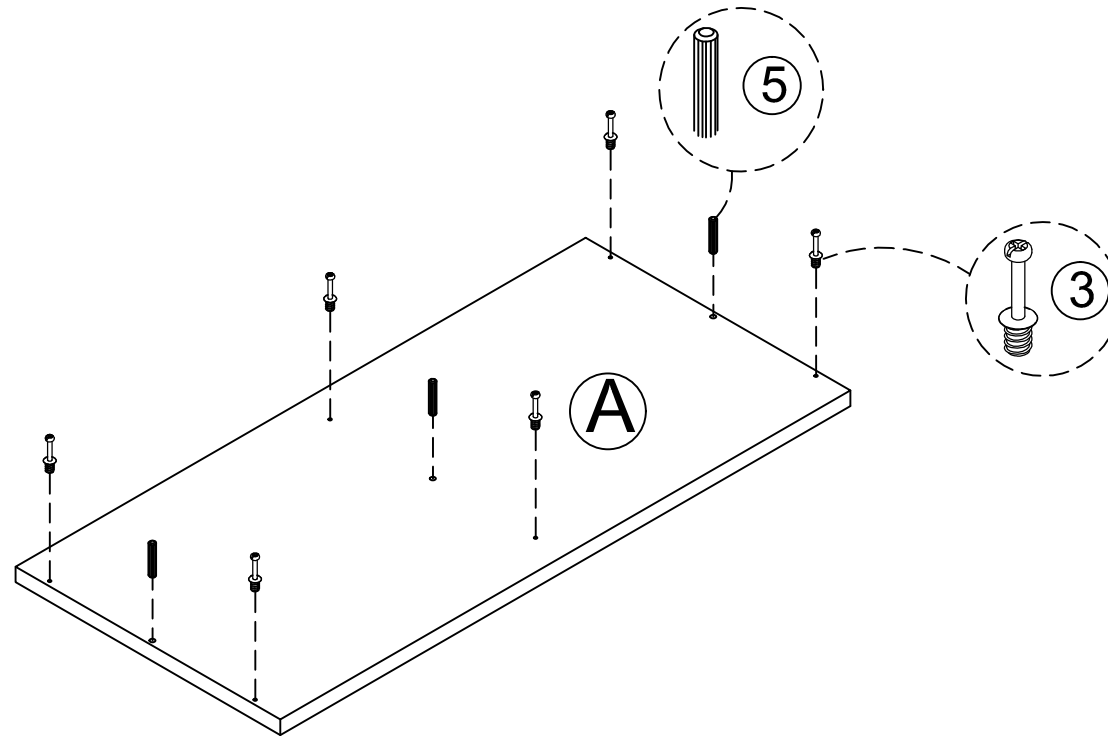

# 2

- Attach panels (D&E&F) to top (A) with six cam locks (2) as below shown.
- Insert three wood dowel (5) into the holes of panels (D&E&F) as below shown.

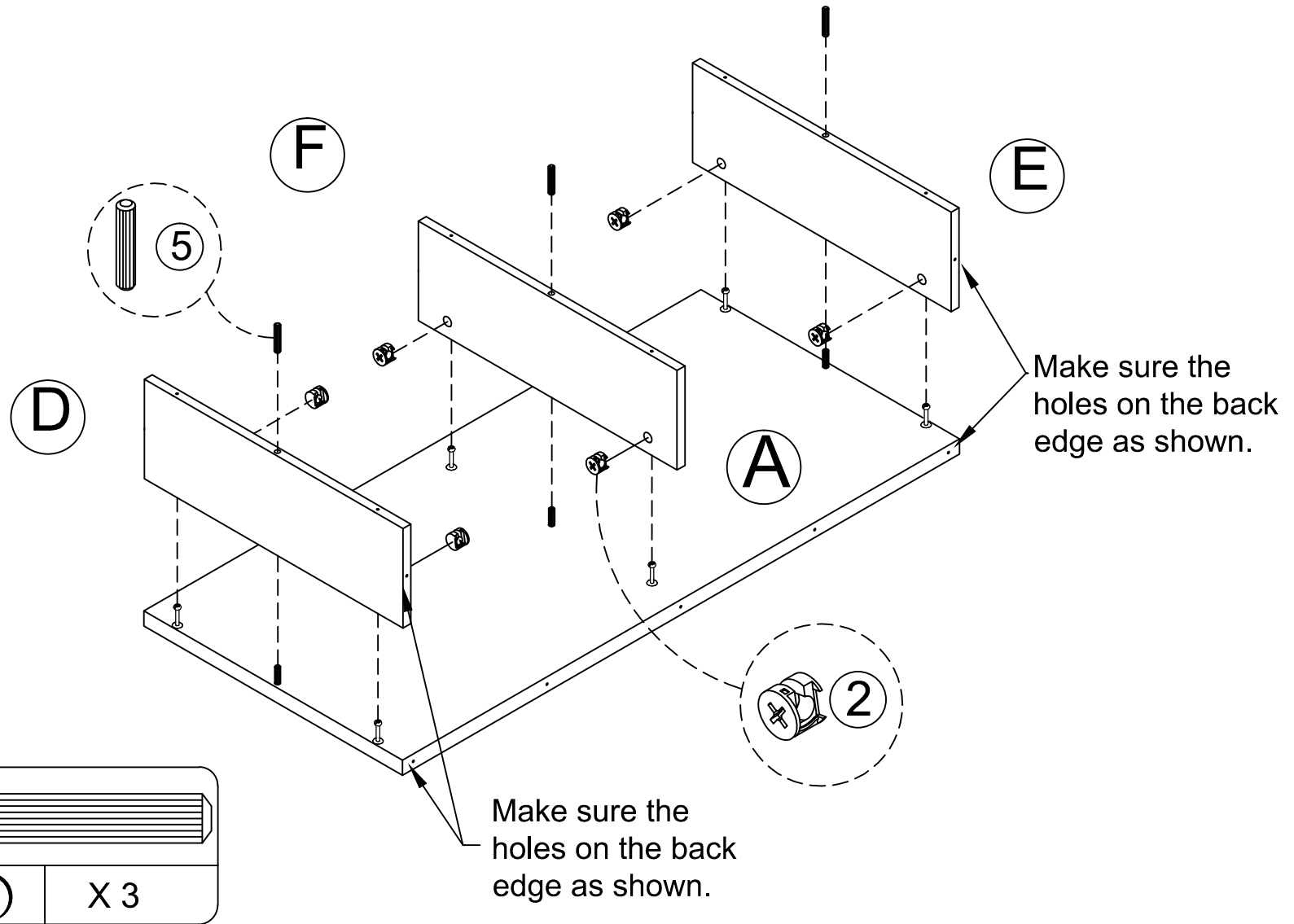

# 3

- Attach bottom (B) to assembled unit with six screws (4) as below shown.

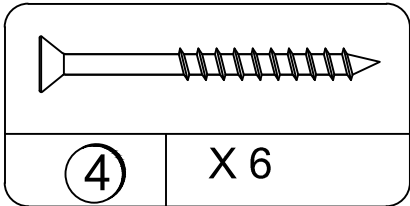
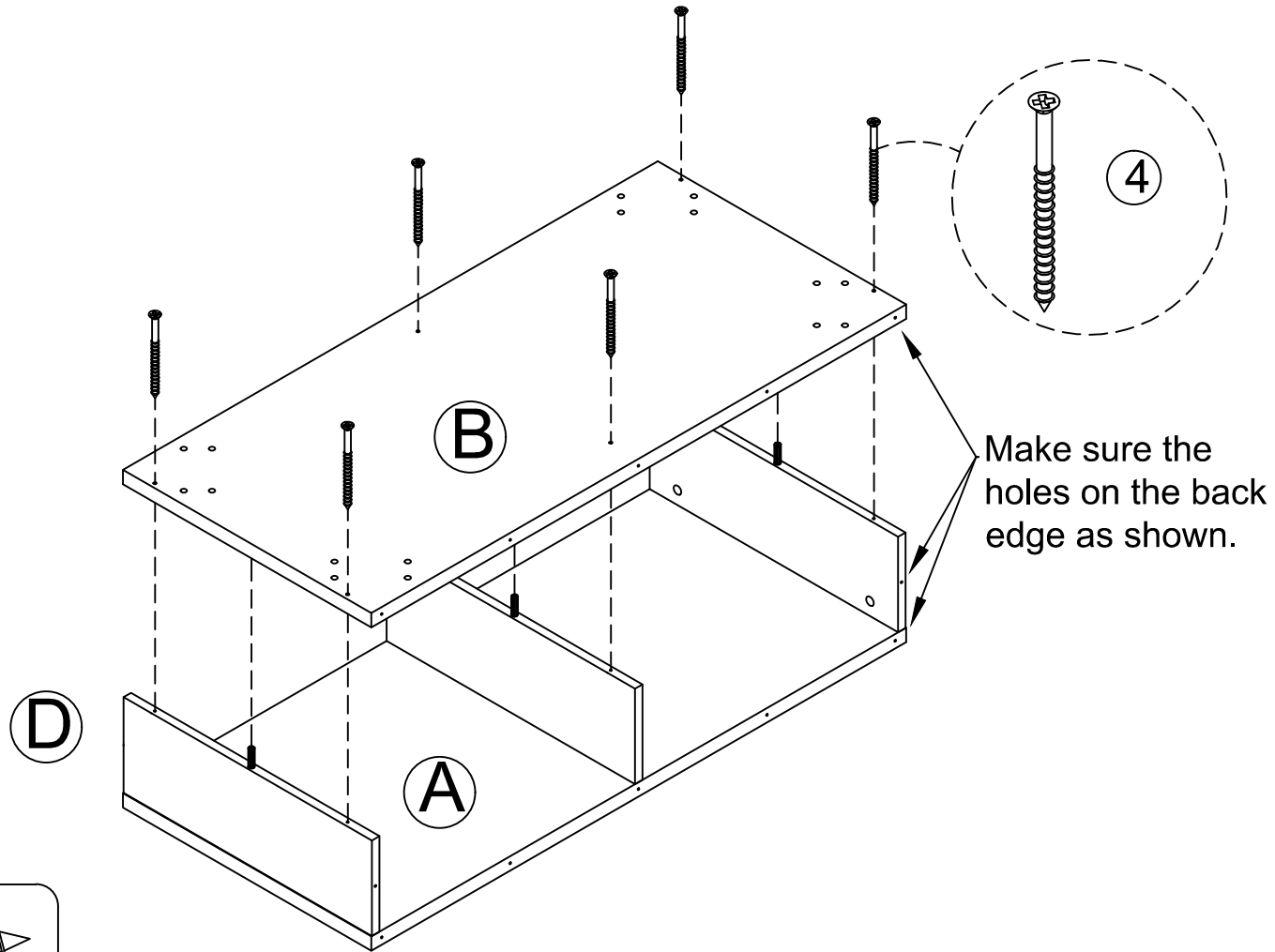

# 4

- Attach back panel (C) to assembled unit with twelve screws (6) as below shown.

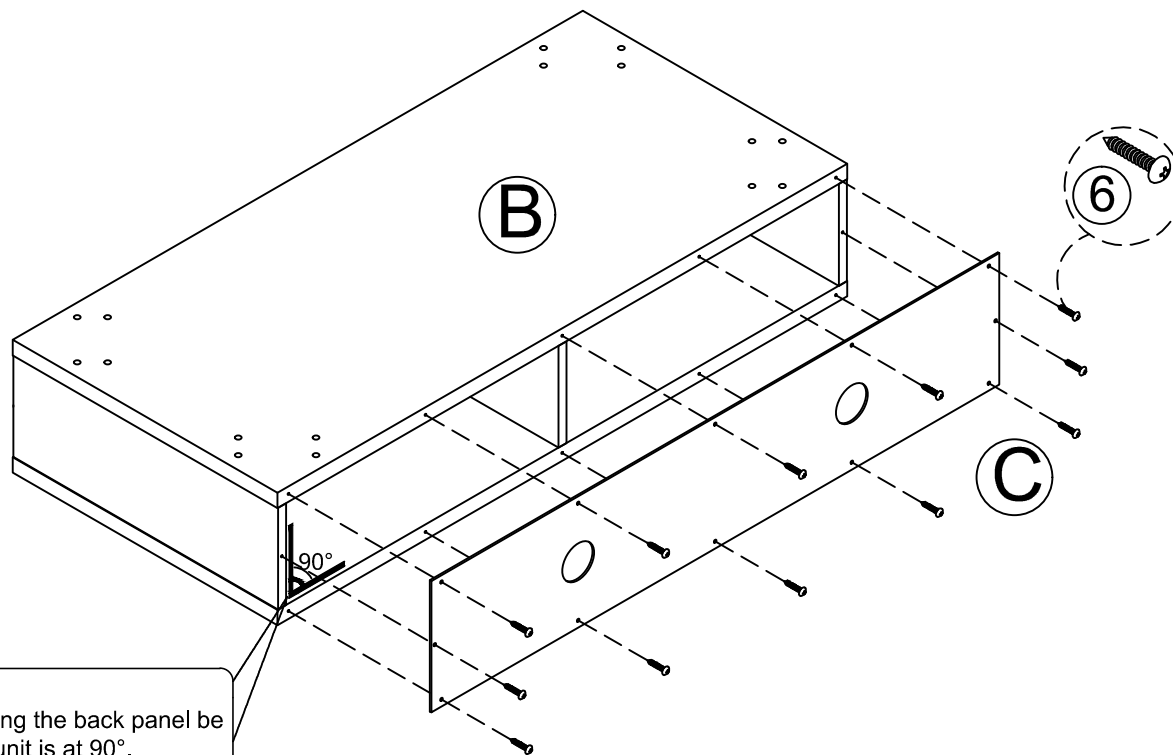

Before attaching the back panel be sure that the unit is at 90°.

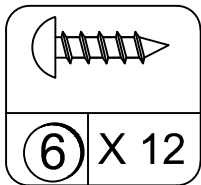



**5** - Attach four legs (G) to assembled unit with sixteen bolts (1) as below shown.

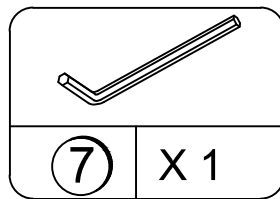
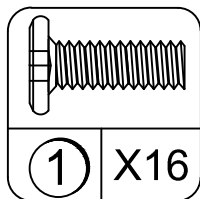
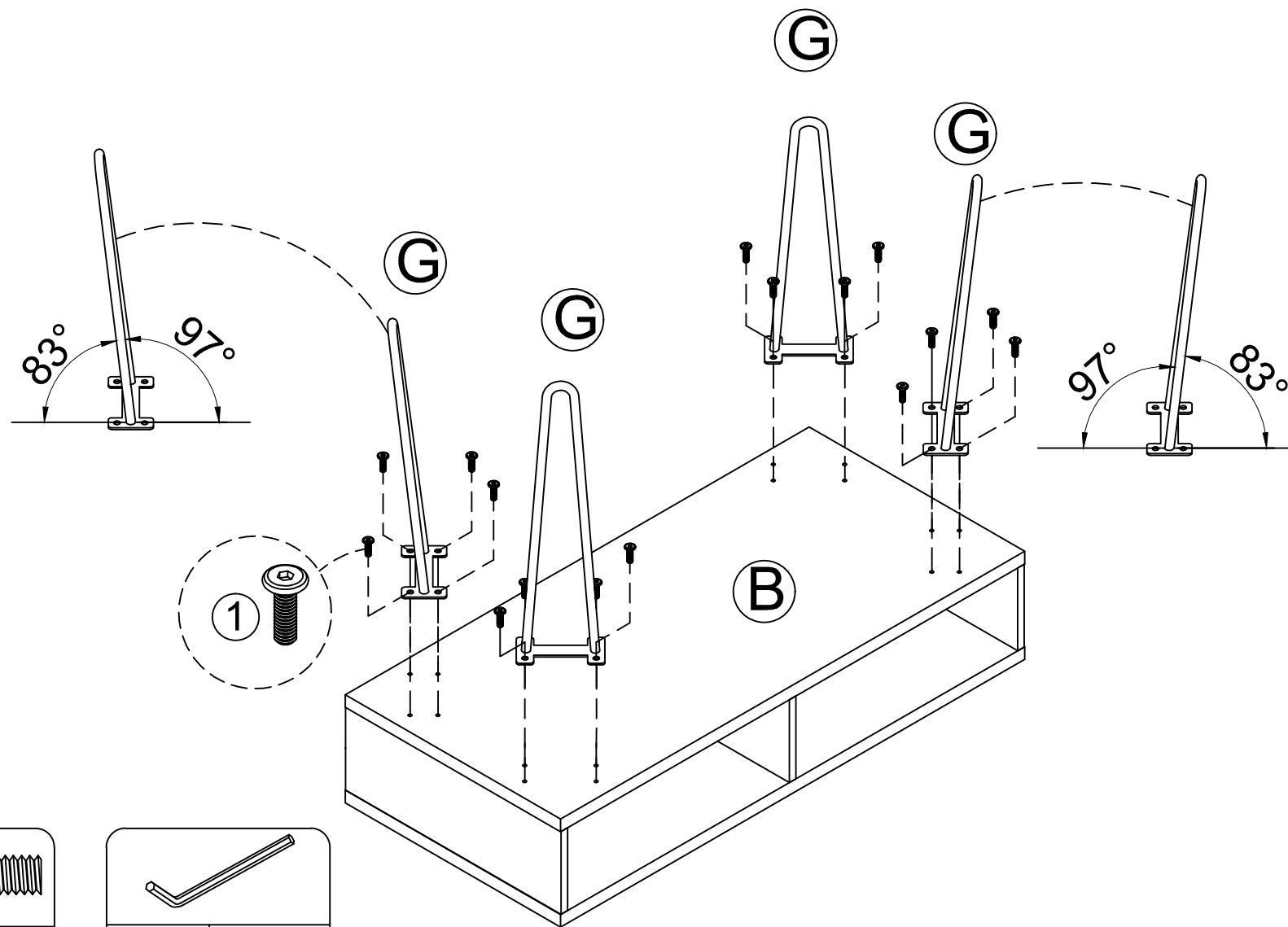

---

Call our toll free number for any assistance you should need or visit our website:

**1-800-489-3351**

[www.ameriwood.com](http://www.ameriwood.com)

Clean the product with your favorite furniture polish and a soft cloth. Do not use harsh chemicals or abrasive cleaners.

Before moving the unit, remove everything including TV from the unit. Move your new furniture carefully with two people. Lift and carry the unit. Never push or drag the unit.

Do not allow children to climb or play on the unit. Failure to comply could result in severe injury.

This unit has been designed to support the maximum loads shown. Exceeding these load limits could cause unit sagging, instability, product collapse and/or serious injury.

Apply the warning label to the TV stand as shown, be sure the TV covers the label in use. You will not be able to remove the label after it is applied to the TV stand.

## WEIGHT LIMITS:

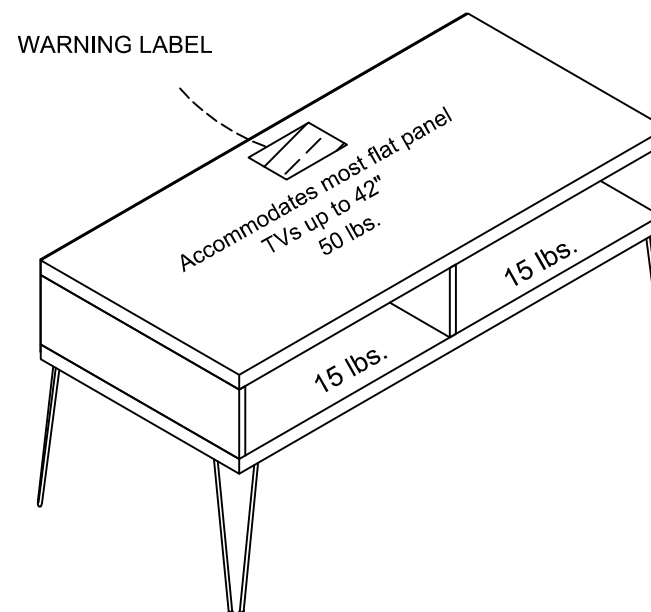

---

# Enjoy Your Furniture