

Vienna

x4

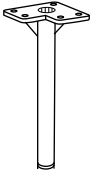

x1

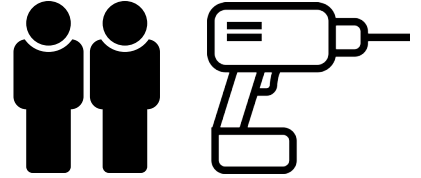
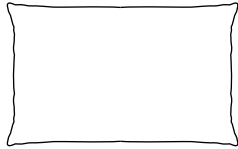

1

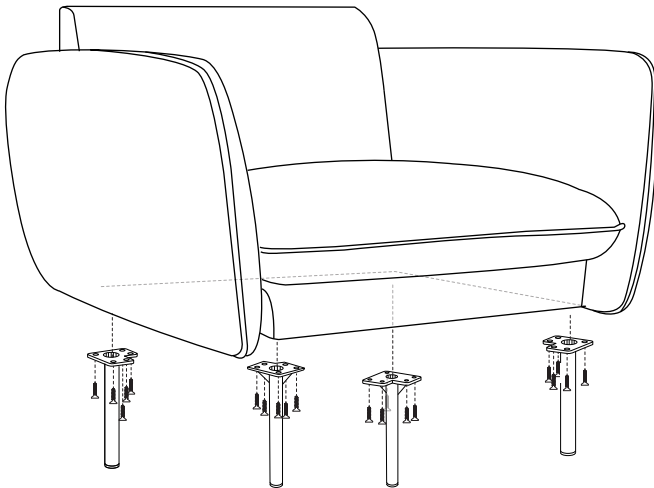

<p>x5 option 1</p>
<p>x4 option 2</p>
<p>x4 option 3</p>
<p>x5 option 4</p>

Legs should be mounted depending on the batch. Check the legs in your kit and mount them as instructed.

SHAPE UP ALL PILLOWS AND CUSHIONS!

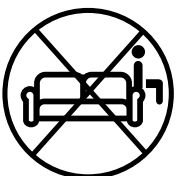

1 of 2

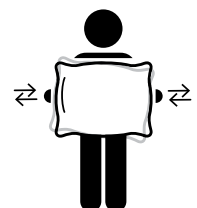

SHAPE UP ALL PILLOWS AND CUSHIONS!

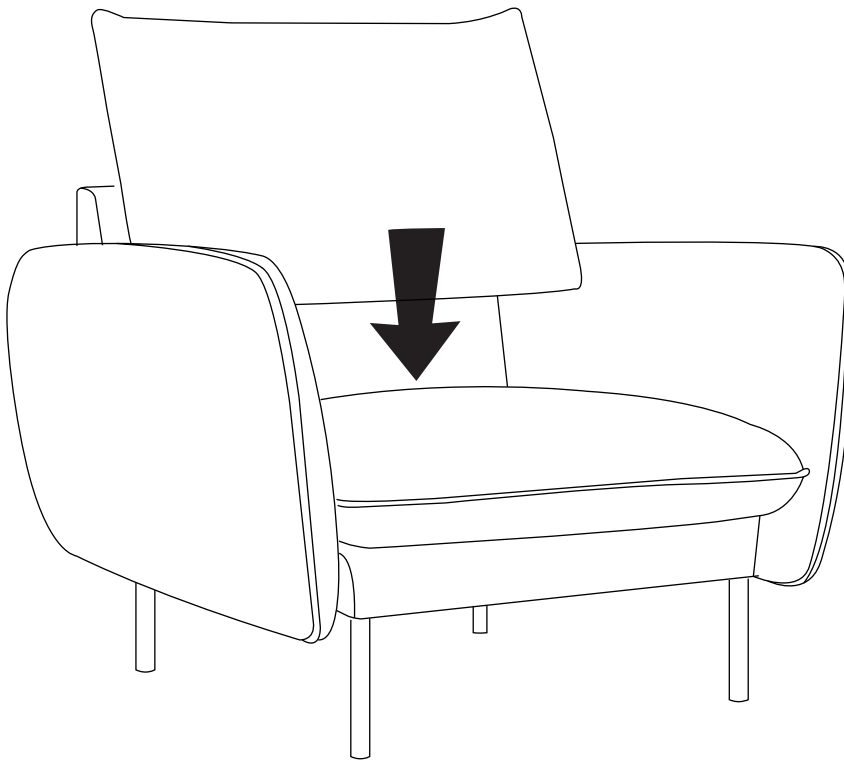
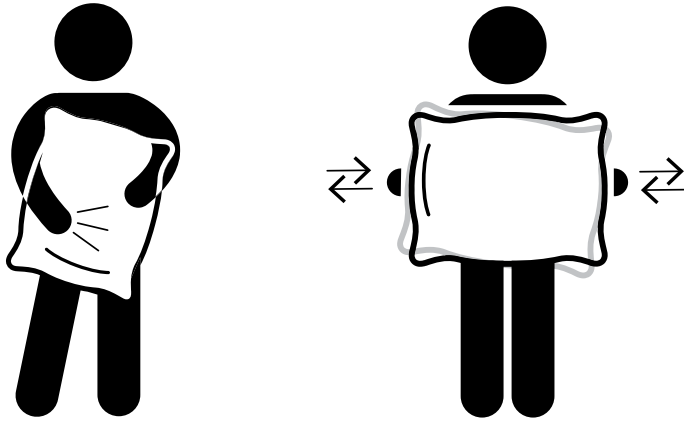

SHAPE UP ALL PILLOWS AND CUSHIONS!

