

ASSEMBLY INSTRUCTION

# FILIPPA DINING TABLE 180

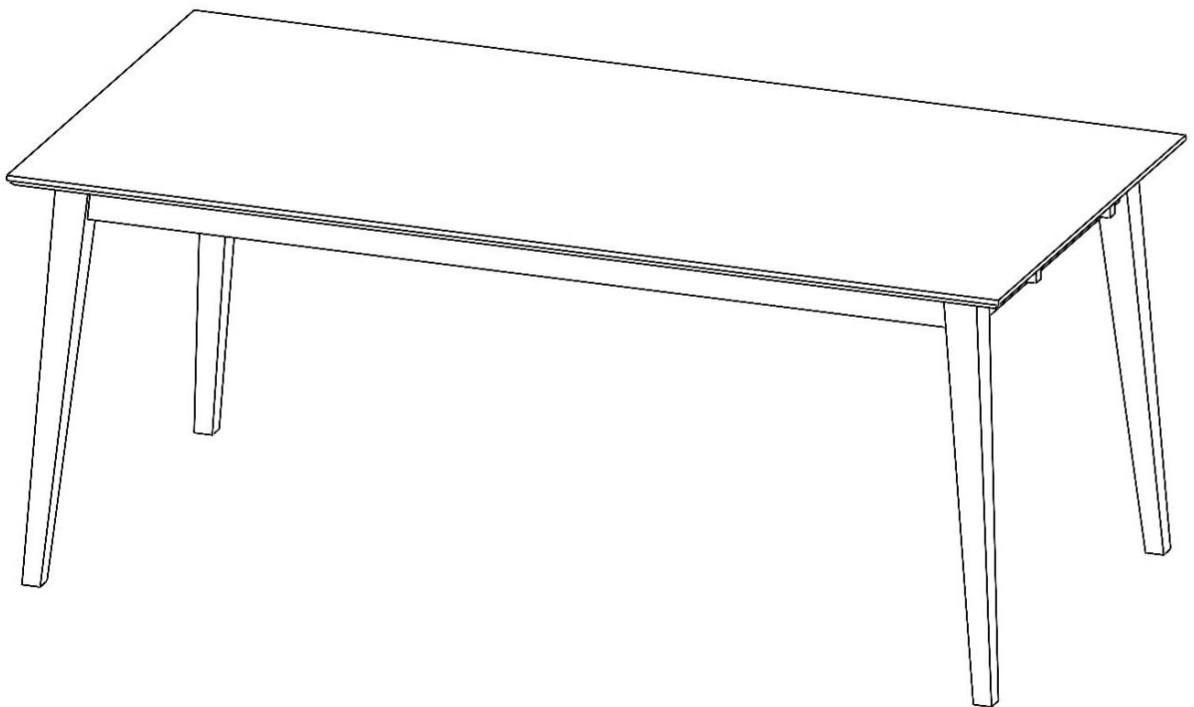



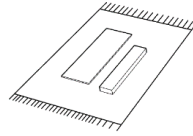
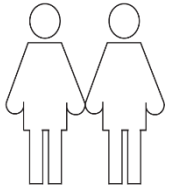

**ROWICO**

HOME



List of part		
	Description	N.o of pcs
A	Table top / Bordskiva	1
B	Table legs/ Bordsben	4

List of hardware		
a		8
b		8
c		1
d		2

### Step 1

