

44590400

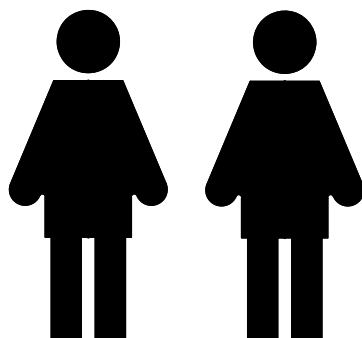
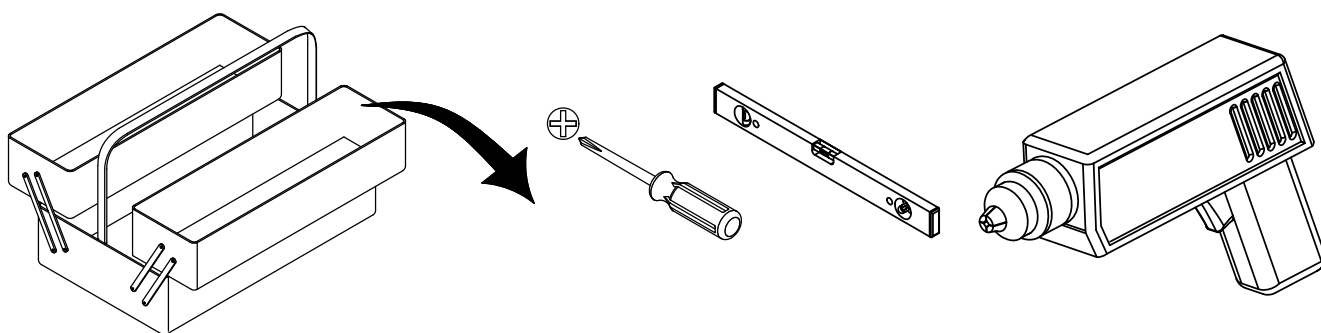
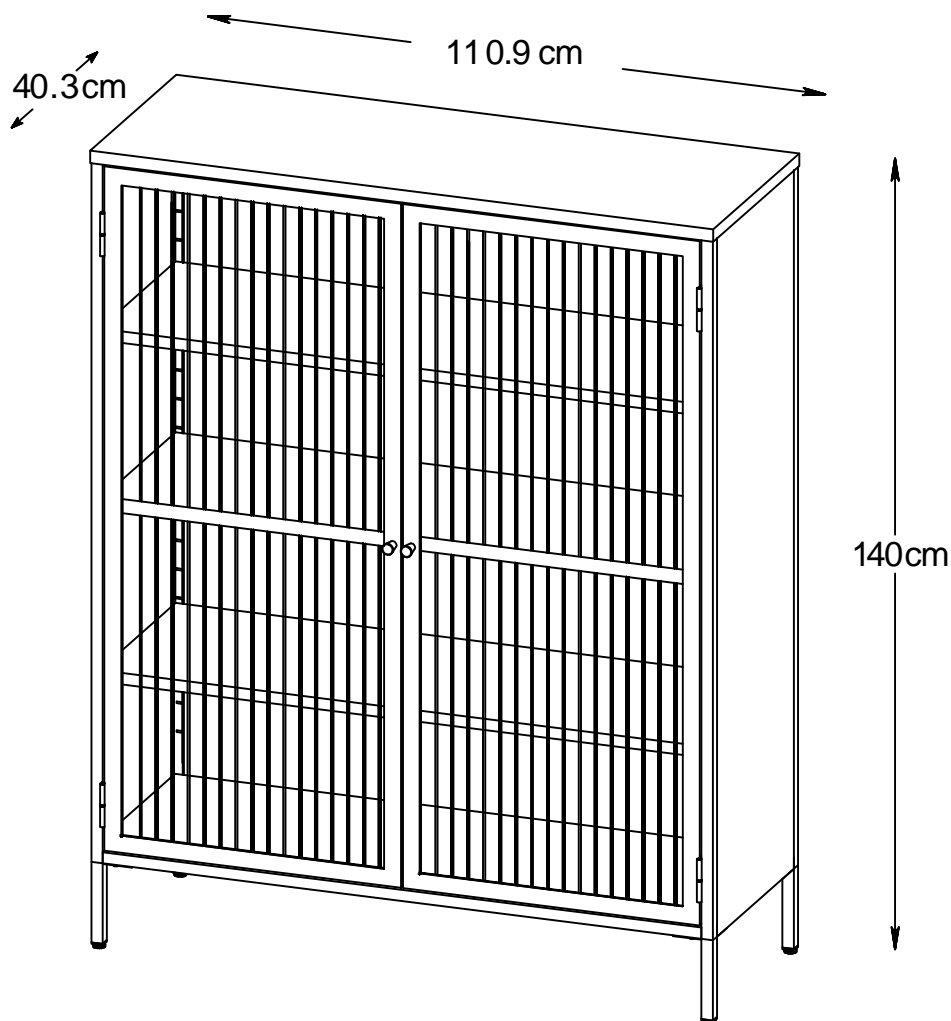

WICHTIG - FÜR SPÄTERE VERWENDUNG
AUFBEWAHREN - SORGFÄLTIG LESEN

AVIS - Ces instructions doivent être sauvegardées
Pour utilisation future - Les instructions doivent
être suivies

IMPORTANTE, conservar estas instrucciones
para futuro uso. Siga estas instrucciones atentamente

VIGTIG - Samvejledningen skal opbevares
i arkiv til senere brug - Skal gennemlæses nøje

NOTICE - These instructions must be saved
for future use - Instructions must be followed





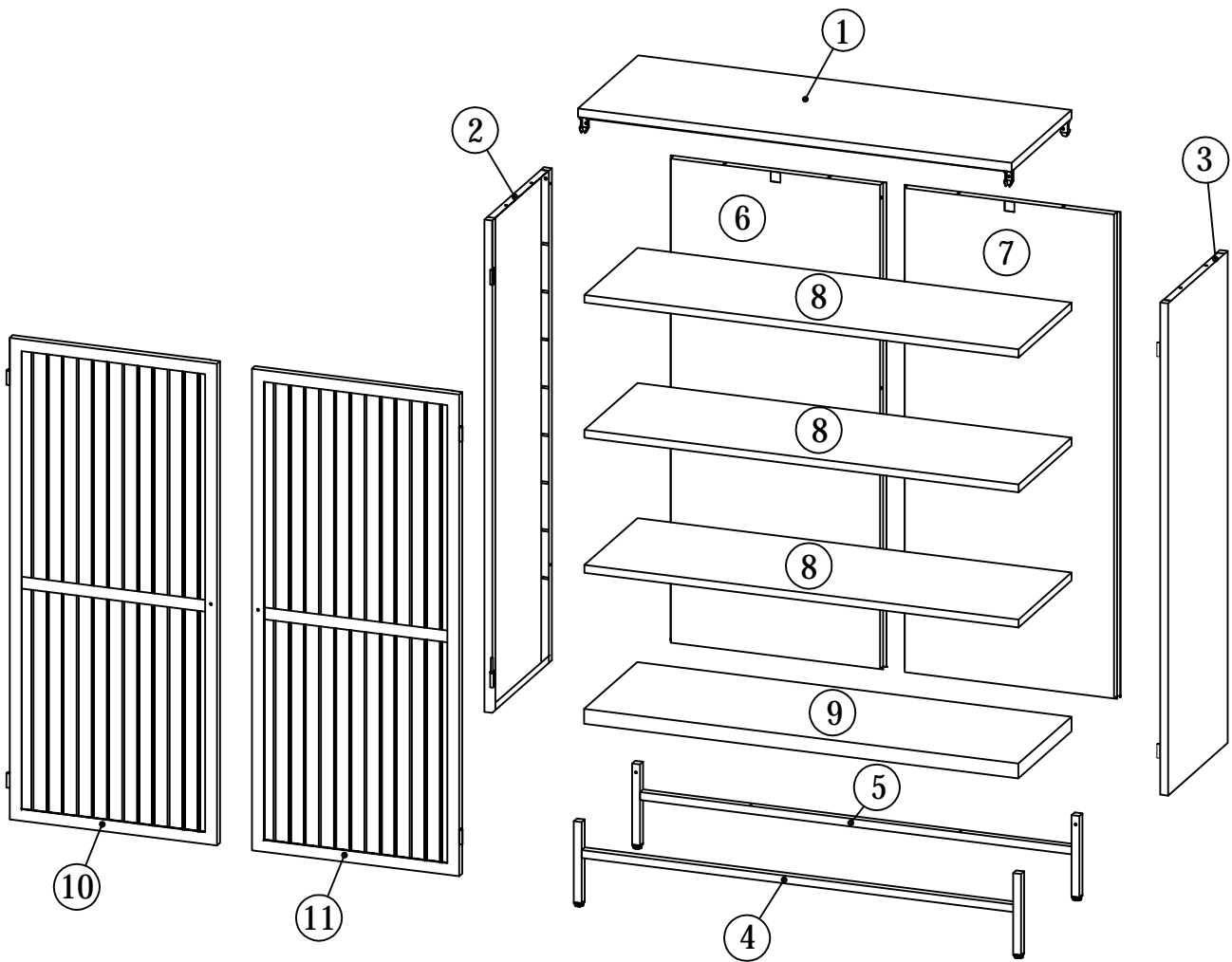

TEILCHECKLISTE
 LISTE DE CONTROLE
 LISTADO DE CONTROL
 TJEKLISTE
 CHECK LIST

Ref./No.	Ref./Art.	Qty./Stck./Quantité	Size / Maß / Dimension (mm)	Qty./Stck./Quantité	✓
1	22796204	1	1109x403x22/62		
2	22796304	1	1230x400x22.5		
3	22796404	1	1230x400x22.5		
4	22796504	1	1105.5x258x20		
5	22796604	1	1105.5x258x20		
6	22796704	1	1224x545x22		
7	22796804	1	1224x537x21		
8	22796904	3	1100x352x21		
9	22797004	1	1100x352x41		
10	22797104	1	1204x527x20		
11	22797204	1	1204x527x20		

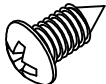
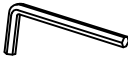
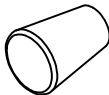

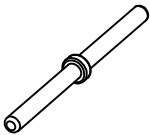
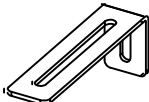
TEILCHECKLISTE - LISTE DE CONTROLE - LISTADO DE CONTROL- TJEKLISTE - CHECK LIST

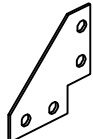
Réf./No.	Réf./Art.	Qty./Stck./Quantité	✓
A	227973	7	
B	227973	32	
C	227973	1	
D	227387	2	
E	227387	2	
F	227387	2	
G	227973	4	
H	227973	2	
I	227973	12	
J	227973	4	
K	227973	3	

7 - A  M6x12mm	32 - B  M4.8x13mm	1 - C  4mm	2 - D 	2 - E 	2 - F  M4x25mm
4 - G 	2 - H 	12 - I 	4 - J 	3 - K  M6	

Geehrter Kunde.
Hier haben Sie die Möglichkeit die mitgelieferten
Schrauben nachzumessen.

Cher Client.
La règle ci jointe vous permet de mesurer la visserie.

Estimado cliente.
aquí podrá medir la tornillería adjunta.

Kære kunde.
Her har De muligheden for at måle medsendte beslag.

Dear Customer.
Below you have the opportunity to measure the
Enclosed Hardware.

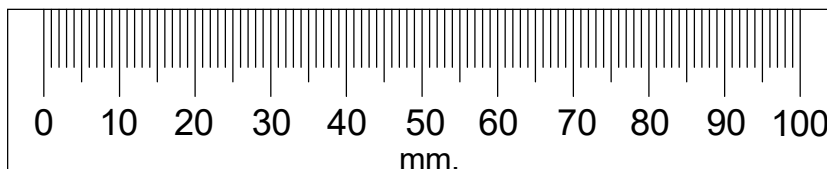

1 4-B  

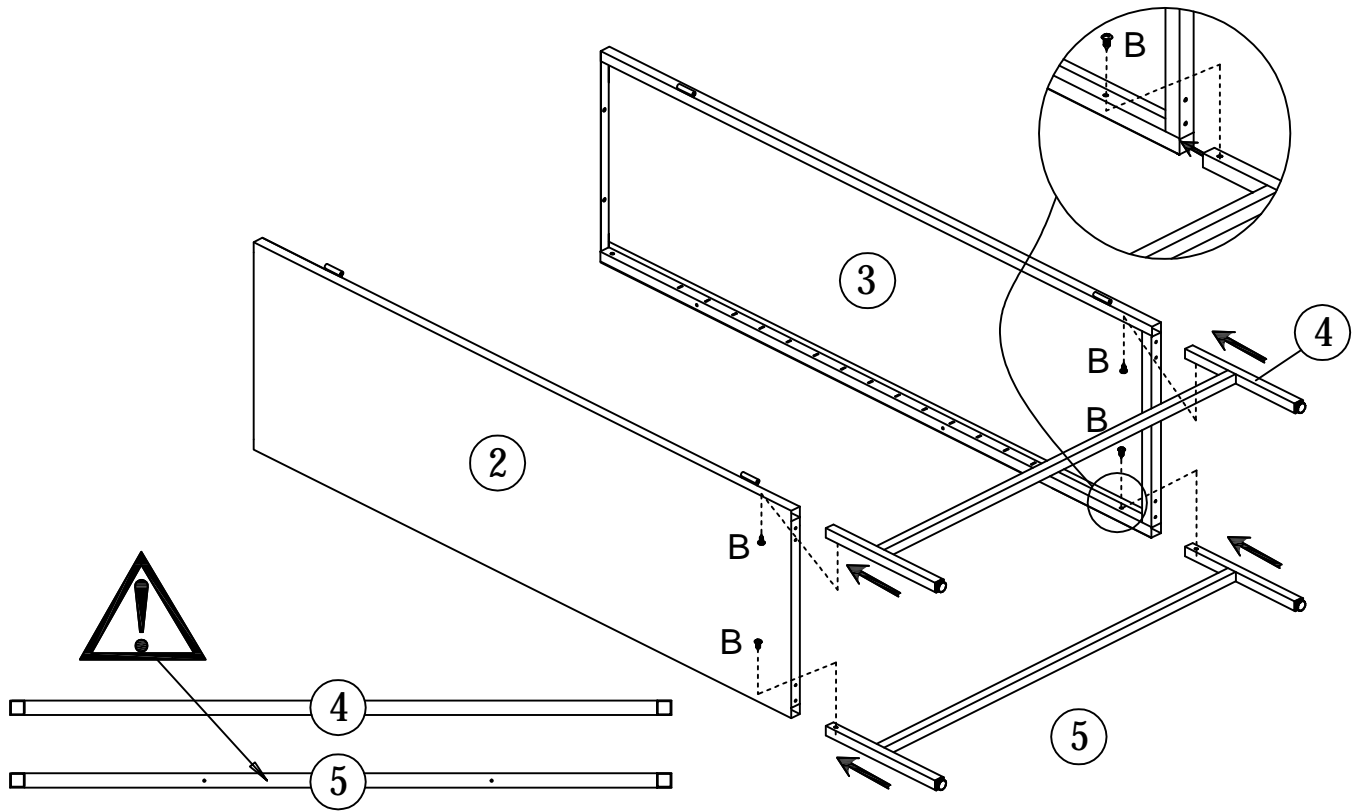

2 16-B 4-J   

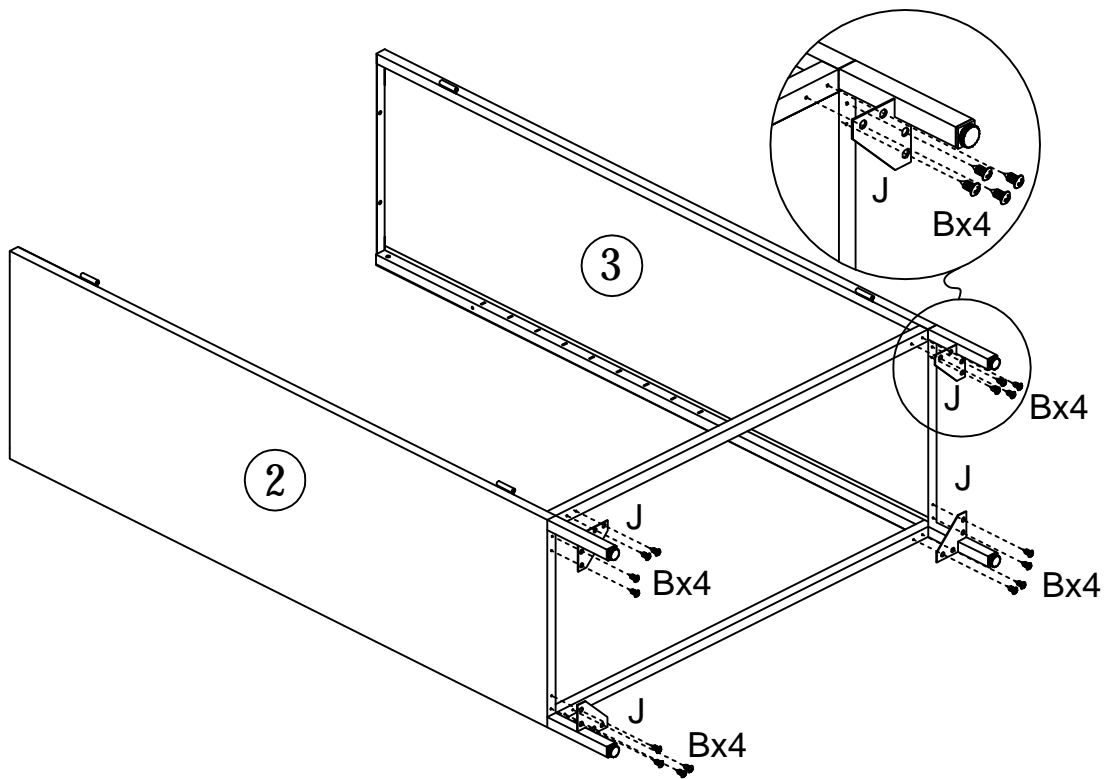

3

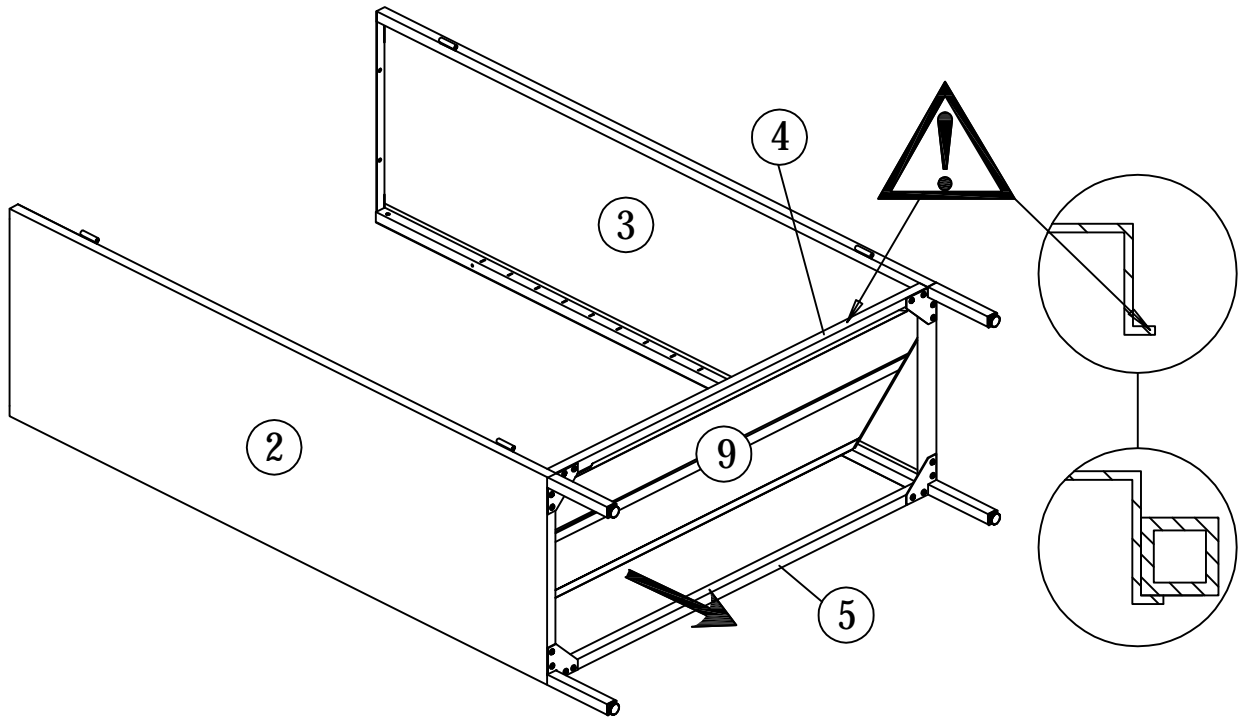

4 4-A 1-C

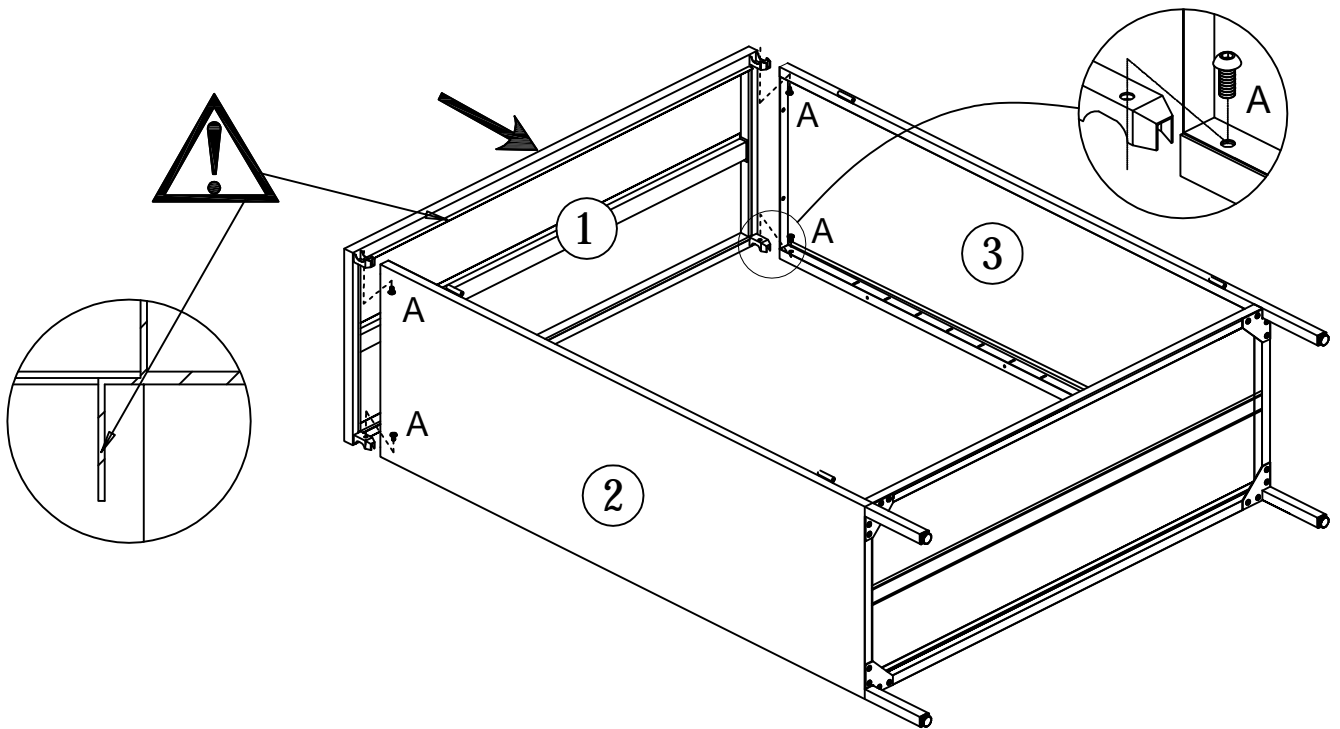

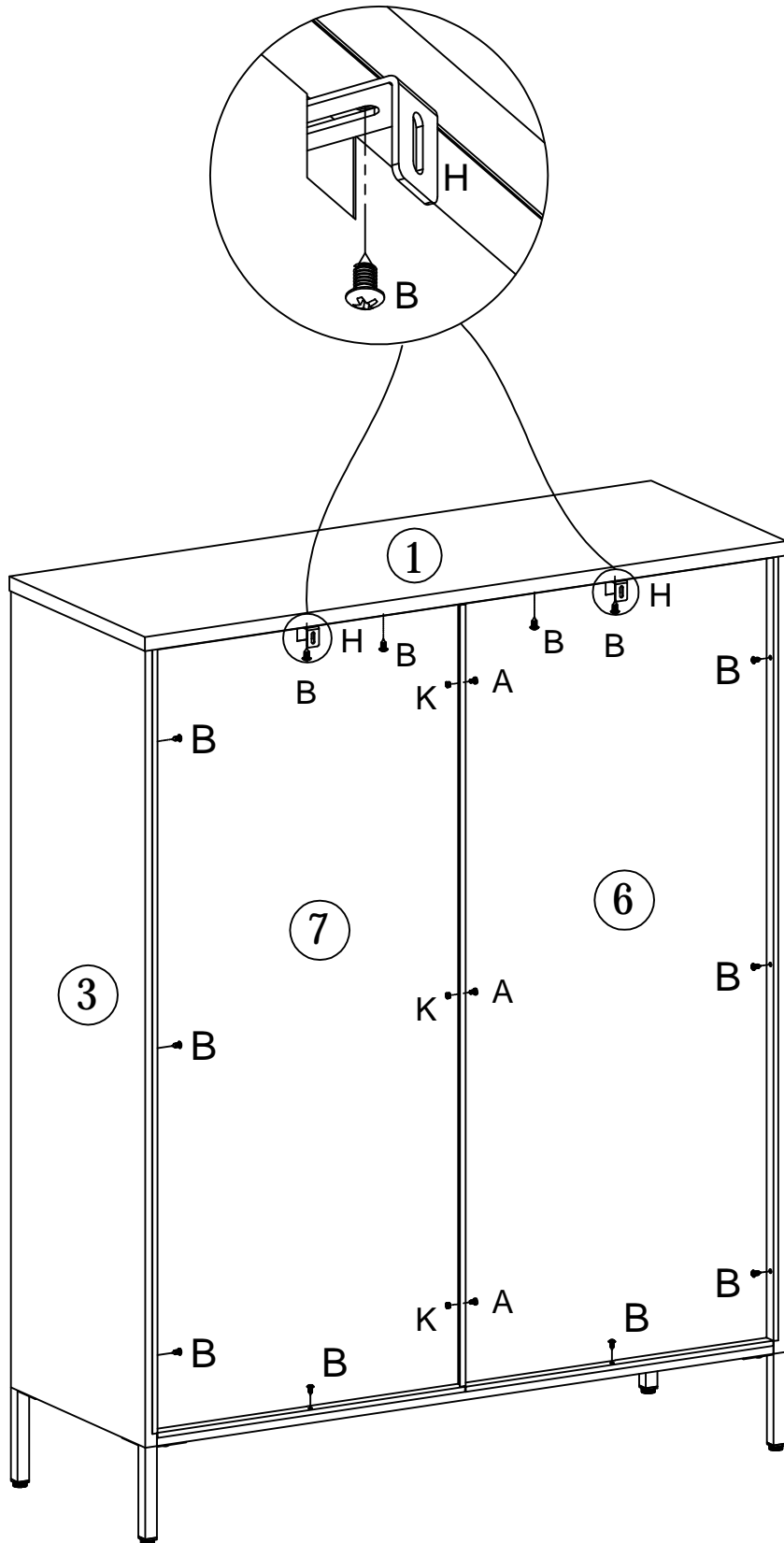

7

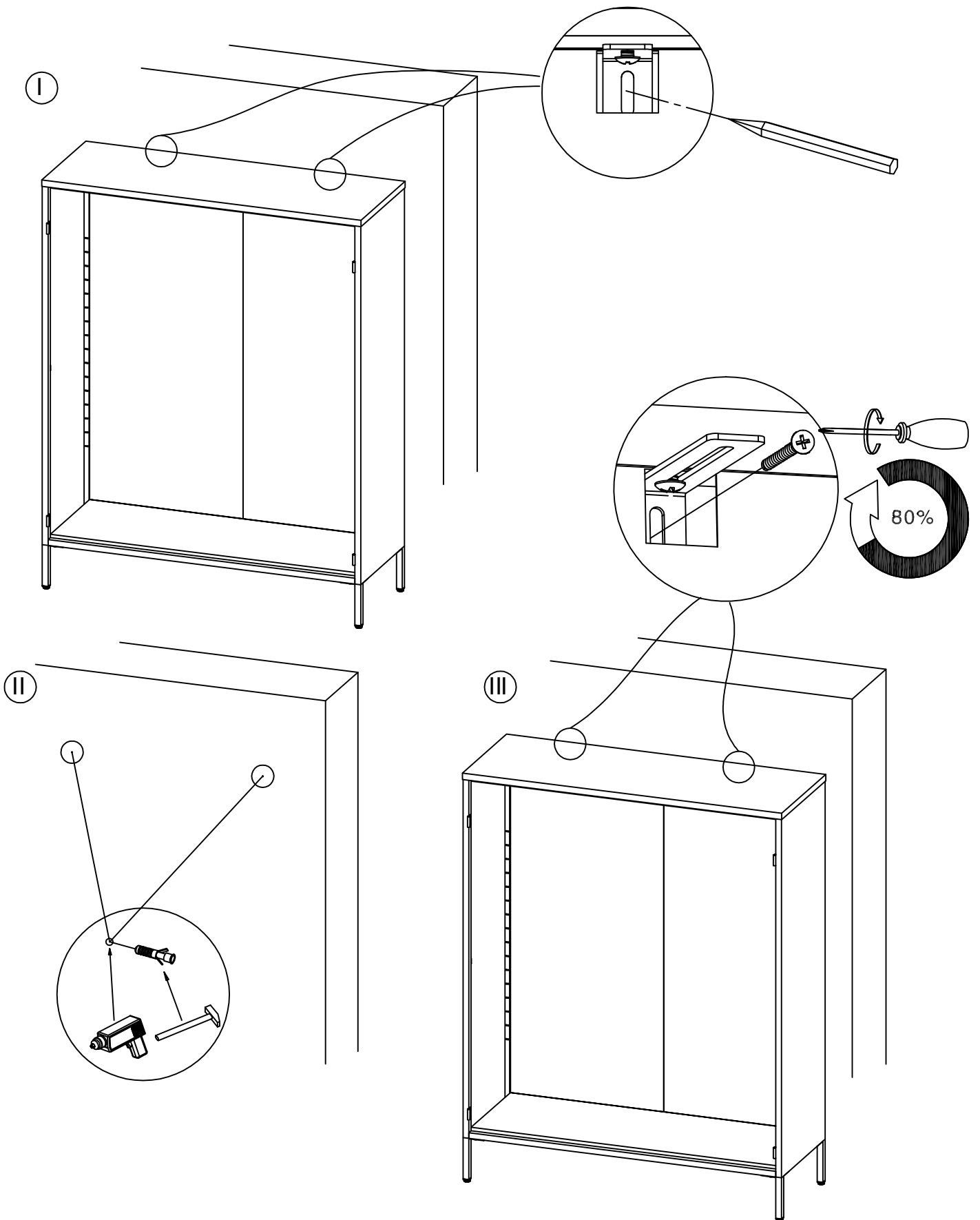

8

12-I

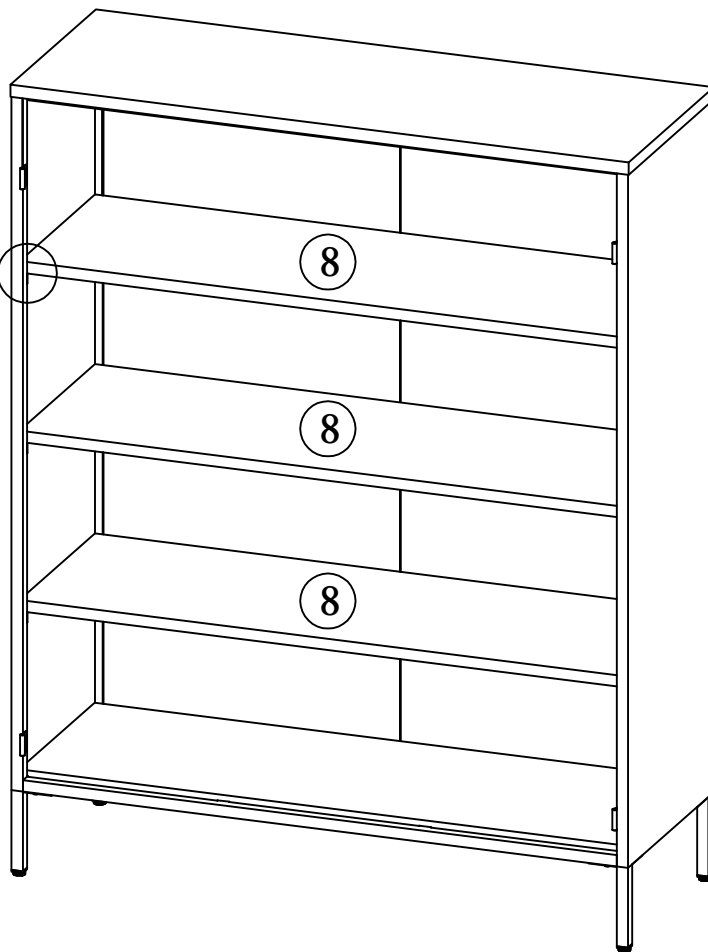
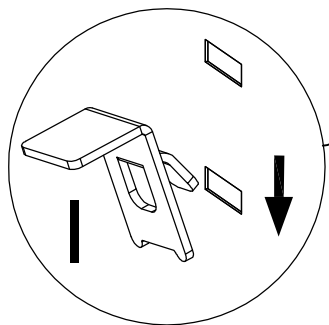

9

2-D



2-F



2-E

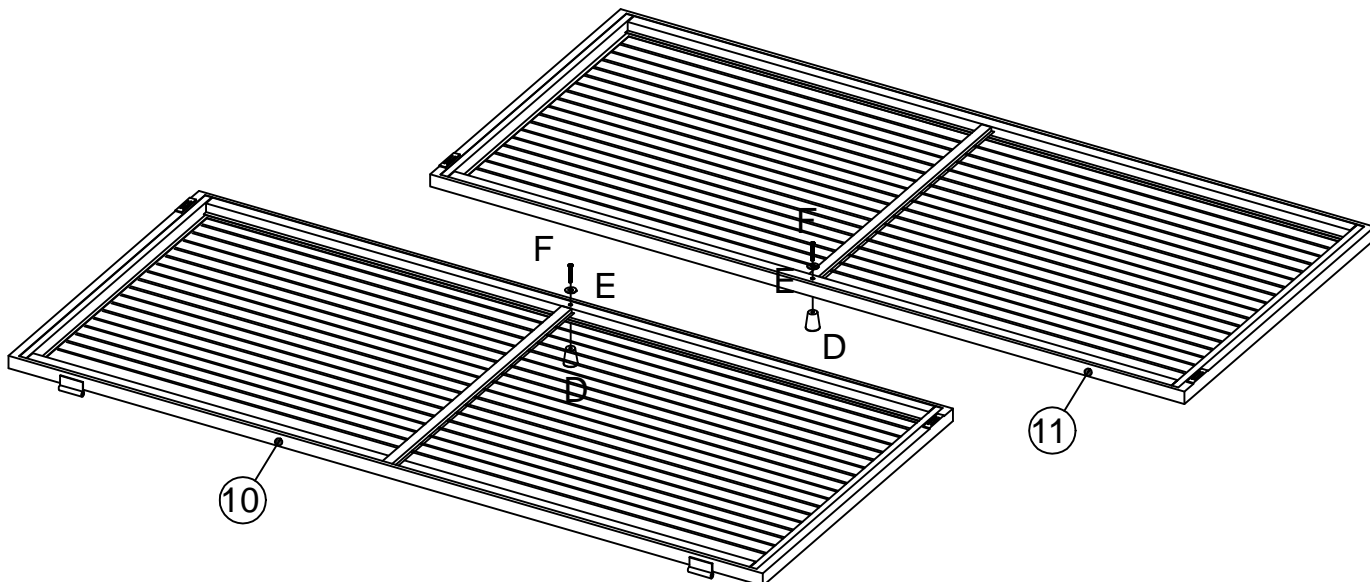
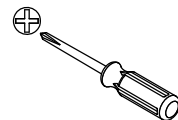

10

4-G

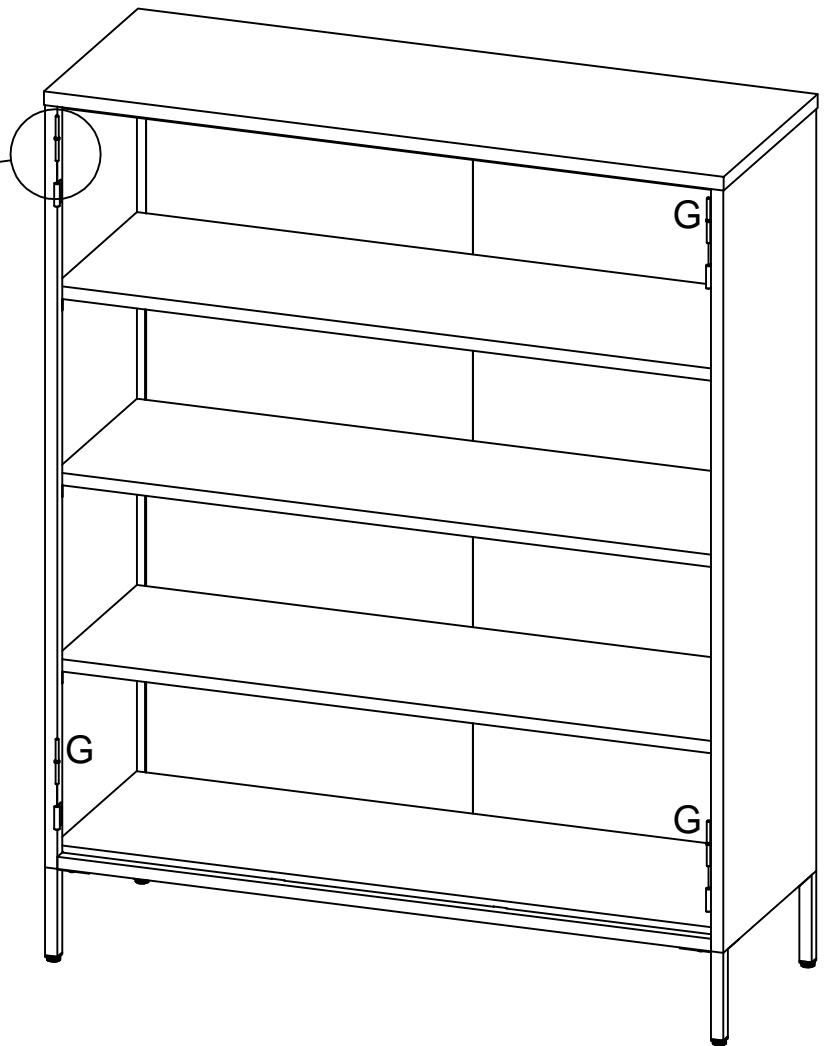
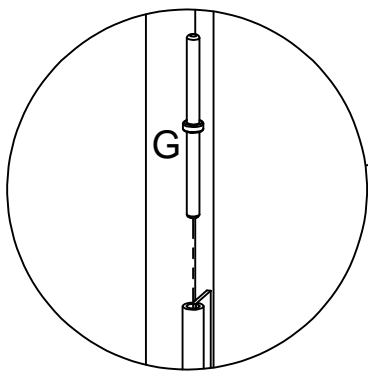
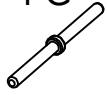

11

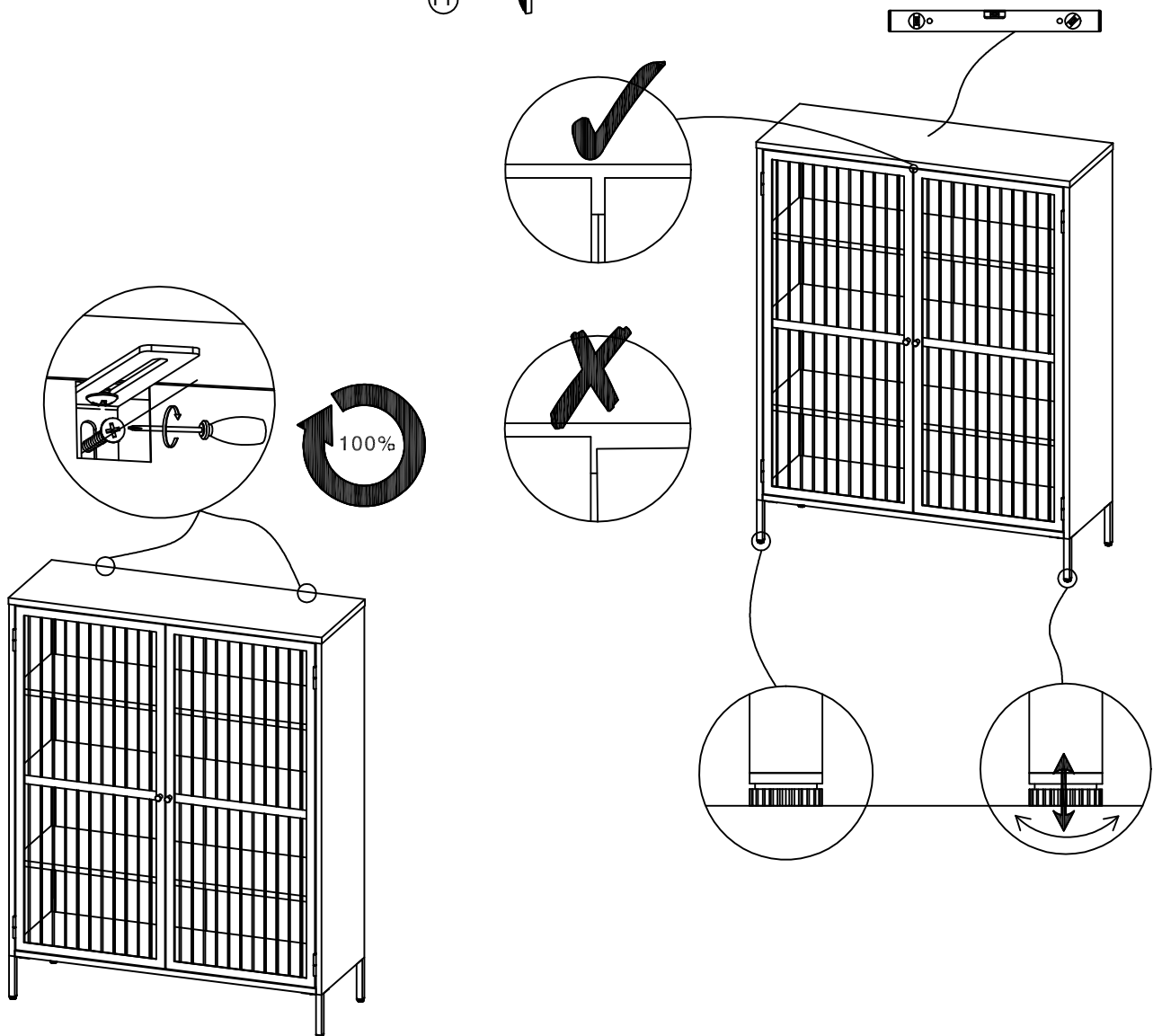
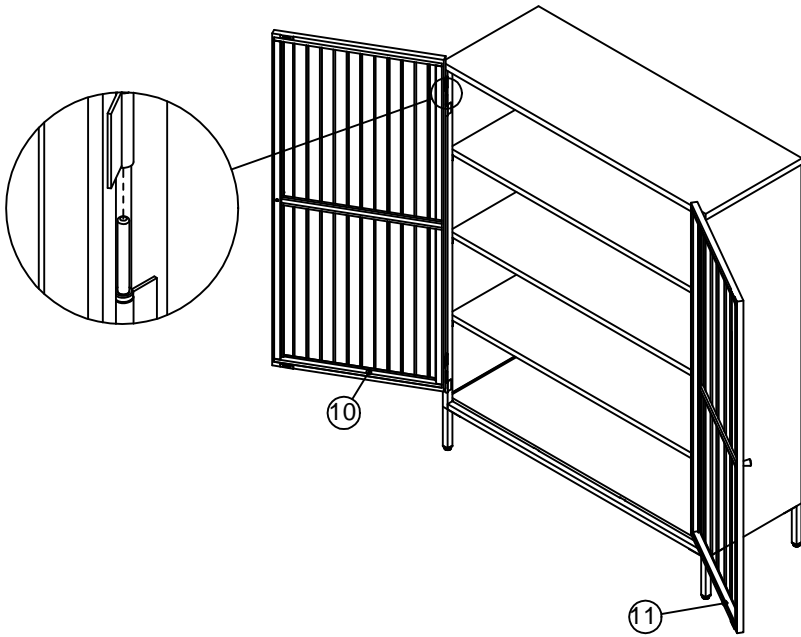
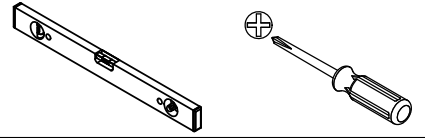

12





UK: To prevent the furniture from tilting it needs to be fastened to the wall using the enclosed safety string.
There are many different types of walls and partitions. We are therefore not able to enclose the correct screws and wall plugs. Before purchasing the appropriate wall plugs and screws, it is essential to find out which type of wall/partition the product needs to be fastened to. Here are some examples of recommended wall plugs/screws for:

DE: Damit das Möbelstück nicht kippen kann, muss es mit der beigegefügte Sicherheitskette an der Wand befestigt werden. Es gibt viele verschiedene Wand- und Abtrennungsarten. Daher ist es uns nicht möglich, die korrekten Schrauben und Dübel mitzuliefern. Bevor Sie die entsprechenden Dübel und Schrauben kaufen, ist es nötig, festzustellen, an welcher Art von Wand/Abtrennung das Produkt befestigt wird. Hier finden Sie einige Beispiele für empfohlene Dübel/Schrauben für:

FR: Afin d'empêcher les meubles de basculer, ils doivent être fixé au mur à l'aide de la chaîne de sûreté fournies. Il y a beaucoup de types de murs et de cloisons différents. Nous ne sommes donc pas en mesure de joindre les vis et chevilles appropriées. Avant d'acheter les chevilles et les vis appropriées, il est essentiel de savoir quel type de mur/cloison du produit doit être fixé. Voici quelques exemples de chevilles/vis recommandées pour:

ITA: Al fine di prevenire il ribaltamento del mobile, è necessario che questo venga fissato alla parete mediante l'utilizzo della stringa di sicurezza allegata. Esistono molte tipologie di pareti e divisori. Non siamo pertanto in grado di allegare tutti i corrispettivi perni e viti di fissaggio. Prima dell'acquisto delle viti o dei perni più appropriati, è necessario individuare il tipo di parete/divisorio a cui il prodotto deve essere fissato. Forniamo di seguito alcuni esempi di perni/viti raccomandati per:

ES: Para evitar que los muebles queden inclinados, estos tienen que fijarse a la pared, usando el cordón de seguridad incluido. Existe una variedad infinita de paredes y tabiques. Por tanto nosotros no somos capaces de incluir los tornillos y tacos de pared apropiados. Antes de comprar los tacos y tornillos de pared correctos, es esencial saber el tipo de pared/tabique al que hay que fijar el producto. He aquí algunos ejemplos de los tacos/tornillos de pared recomendados para:

CAT: Per tal d'evitar que el moble s'inclini, cal collar-lo a la paret amb el cordó de seguretat inclòs. Hi ha diferents menes de parets i envans. Per aquest motiu no podem incloure els cargols i els tacs adequats per a totes les parets. Abans de comprar els cargols i els tacs adequats, cal esbrinar a quina mena de paret o envà anirà muntat el producte. Aquí teniu alguns exemples de cargols i tacs recomanats per a:

UK: Brick Walls
DE: Ziegelwände
FR: Murs de briques
ITA: Pareti di mattoni
ES: Paredes de ladrillo
CAT: Parets de totxo

UK: Nylon Plug "Fisher"
DE: Nylon-Dübel "Fischer"
FR: Cheville en nylon à expansion "Fisher"
ITA: Press "Fisher" in nylon
ES: Taco de Nylon "Fischer"
CAT: Tac de niló "Fischer"

Metal expansion bolt
Metall-Dehnschraube
Boulon à expansion en métal
Perni ad espansione in metallo
Taco metálico expansible
Cargol d'expansió metal·lic

Nylon expansion bolt
Nylon-Dehnschraube
Boulon à expansion en nylon
Perni ad espansione in nylon
Taco expansible de nylon
Cargol d'expansió de niló

Cavity anchor
Hohlraumdübel
Cheville de verrouillage
Cavità di ancoraggio
Anciaje de pared hueca
Ancoratge per a cavitats

Cavity anchor "Molly"
Hohlraumdübel "Molly"
Cheville de verrouillage de forme "Molly"
Cavità di ancoraggio "Molly"
Anciaje de pared hueca "Molly"
Ancoratge per a cavitats de tipus "Molly"

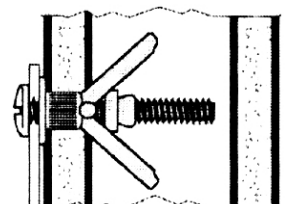
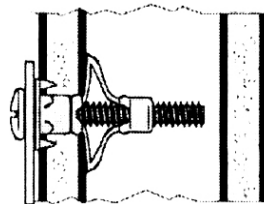
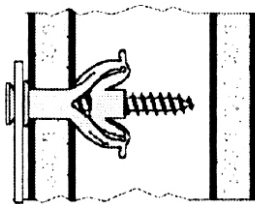
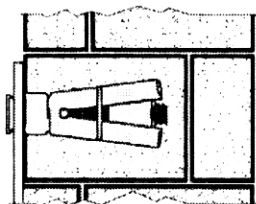
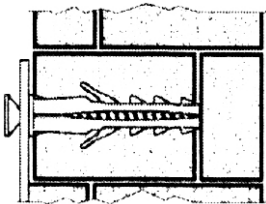
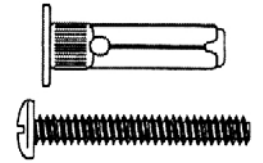
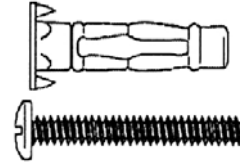
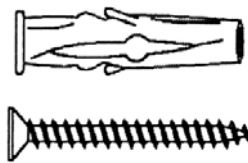
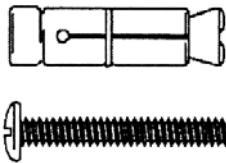
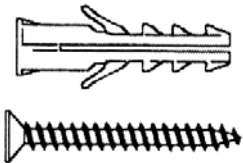

UK: Use a drill suitable for the type of wall and the chosen wall plug.
DE: Verwenden Sie einen für die Wand und die gewählte Dübelart passenden Bohrer.
FR: Utiliser une perceuse appropriée pour le type de mur et la prise murale choisie.
ITA: Utilizzare un trapano adatto al tipo di parete e al tipo di perno selezionato.
ES: Utilice una máquina taladradora adecuada para el tipo de pared y el taco preferido.
CAT: Cal fer servir una broca adequada per al tipus de paret i el tac escollit.